

P A R K E R
S E R V I C E M A N U A L

The Parker Pen Company
Export Department
Janesville, Wisconsin, U.S.A.

No. 6996-E

Printed in U.S.A.

Contents

	<u>Page</u>
<u>Duofold and Challenger Pens</u>	3
Disassembly	4
Assembly	4
Nib Adjustment	15
<u>Parker Vacumatic Pen</u>	23
Disassembly	24
Assembly	29
<u>Parker "51" Vac-fil Pen</u>	35
Disassembly	36
Assembly	45
Nib Adjustment	46
<u>Parker "51" Aero-metric Pen</u>	52
Disassembly	55
Assembly	55
Weir Vent	56
<u>Parker "51" Pencil</u>	59
<u>Parker "21" Pen</u>	63
Disassembly	64
Assembly	64
<u>Parker "21" Pencil</u>	71
<u>Cleaning Solutions</u>	72
<u>Reference Fitting Chart</u>	73, 74
<u>List of Repair Tools</u>	75, 76

PARKER SAC BUTTON-FILL PENS

DUOFOLDS - CHALLENGERS

The best known of the sac button-fill pens manufactured by The Parker Pen Company were the Duofold models of the 1920's which were manufactured in three sizes:

1. The Lady Duofold
2. The Junior Duofold
3. The Senior Duofold

Others were the Lady and Junior Challenger, Lady and Junior Challenger Deluxe and Lady and Junior Royal Challenger.

Figures 1 and 2 illustrate the parts that make up a typical sac button-fill pen. This particular pen is the Junior Duofold.

On the back end of the pen barrel is a small cap called the blind cap. When this cap is unscrewed, a button known as the pressure button is exposed. Depressing the pressure button causes the pressure bar to warp out of shape momentarily and collapses the sac against the opposite barrel wall.

To fill the pen, submerge the entire nib below the surface of the ink, depress the pressure button (which compresses the sac), release it, and hold the nib below the surface of the ink until the sac has had ample opportunity to regain its original shape.

Inserted into the front end of the barrel of the pen is the section. The feed and nib are fitted into the front end of this section by means of a friction fit. The back end of the feed is exposed to the ink in the reservoir and the function of the feed is to meter ink to the nib at a steady rate. This is done by means of the main channel and capillary cuts. Figure 3.

When servicing these pens, it is advisable to run a spacing steel down through the capillary cuts in the feed.

The original nib in the Parker Duofold was made of 14 carat gold tipped with a pellet of very hard metal known as osmiridium. The present replacement nibs are tipped with an even better metal known as ruthenium.

The cap assembly (consisting of three main parts--the outer cap, clip and inner cap) must be tightly screwed to the barrel to form an air tight seal. This should be called to the attention of the customer.

The cap is vented by means of two holes drilled directly beneath the lower level of the inner cap. The purpose of these holes is to create a flow of air around the section and avoid condensation forming on the section. They also prevent any pump-like or sucking action on the nib and feed when the cap is removed. In servicing these pens make sure the holes are open by running a small drill through them.

The metal band or banding of the cap serves a functional as well as an ornamental purpose, preventing the plastic of the cap from expanding and cracking when the cap is placed on the upper end of the barrel.

DISASSEMBLY

The first step is to remove all the ink. Then fill the pen with one of the cleansing solutions indicated at the back of the manual. Follow with a cold water flush.

The pressure button is removed by hooking the end of the pressure button in the notch provided for this purpose in your Disassembly Block No. 9592R1.

A straight pull on the barrel of the pen removes the pressure button. Remove the pressure bar by grasping the end of the bar with the nib pliers and pulling the bar straight out from the end of the barrel. If the pressure bar catches, move it back and forth gently as you pull it out. Figure 4.

To remove the section from the barrel, grasp it at the center with your rubber-covered section pliers and with the other hand, grasp the barrel using a piece of flat rubber. A sharp twist, turning the section in a counter-clockwise direction, will loosen the section in the barrel. If it is a slip section, turn it loosely from the barrel and pull it straight out. Do not rock the section in an effort to break it free from the barrel as this rocking motion may split the barrel threads. Figure 5.

If the section refuses to pull out, it has probably been glued tightly into the barrel. To break this glue seal, lay the barrel flat on a workbench and tap lightly on the threads with the rubber-covered jaws of the section pliers, turning the barrel as you tap the threads. If this fails to break the section free, carefully apply heat to the threads of the barrel. This may be done by dropping very hot water (approximately 150° Fahrenheit) onto the outside of the threads with an eye dropper. This is the safest method as direct application of flame is liable to ignite the barrel.

Occasionally the sac will remain stuck to the inside barrel wall. Pouring a small quantity of any high grade lighter fluid into the barrel will soften the rubber and it then can be removed by use of the Hook Tool No. 10201.

The next step is to separate the sac from the nipple of the section. Should some of the sac tear off and remain stuck, it will be necessary to use a small knife or a flat file to remove all of the old rubber.

The metal-faced disassembly block listed in the repair tool assortment at the end of the manual is designed for the disassembly of the Lady, Junior and Senior pens. First place the nib and feed of the Duofold pen into the collar of the block. Then, placing the knock-out rod with the hollowed or drilled end down directly on the back of the feed, drive the feed straight out of the section with a few light blows of a small hammer. Do not allow the knock-out rod to slant to one side as you drive out the feed as this may break the nipple of the section. A straight, downward blow is required. Nib, feed and section of the pen are now completely disassembled. Figure 6.

ASSEMBLY

Inspection of each part of the pen is the most important step of reassembly. Inspect the feed of the pen. Make sure that the tip of the feed and the comb-like cuts on the sides of the feed are not broken or chipped. Open the capillary channels in the feed using the piece of fine spacing steel supplied in your kit as indicated in Figure 7. Then, using a flat brush remove all dirt and sediment from the half-moon cuts of the feed. If sediment remains on these channels or half-moon cuts, the ink will not flow evenly.

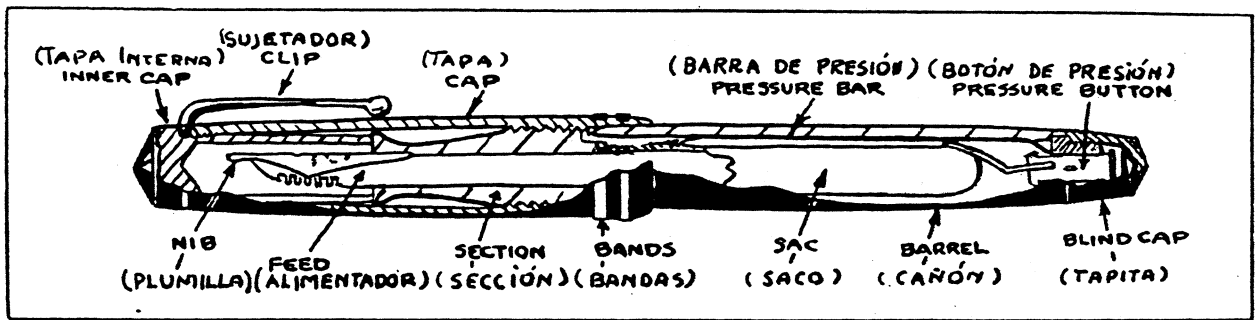

Fig. 1

PARTS FOR SAC PENS (BUTTON FILLING)

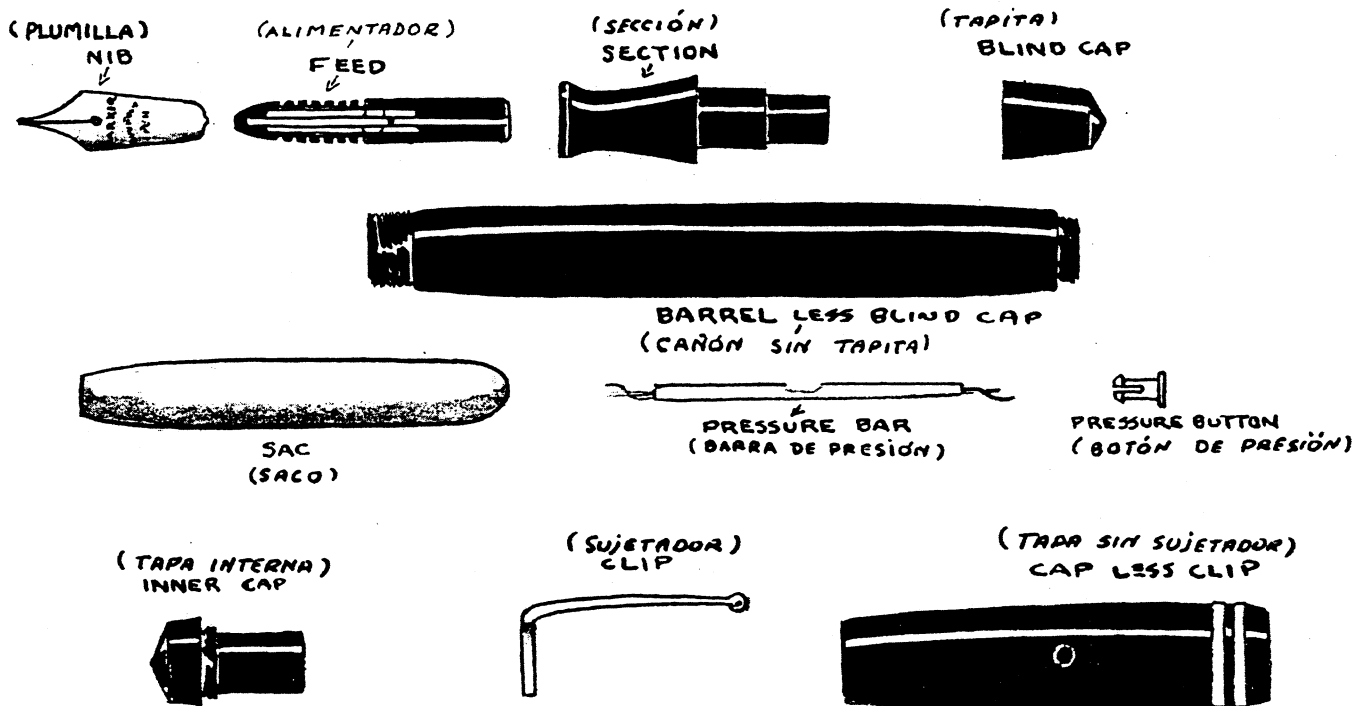

Fig. 2

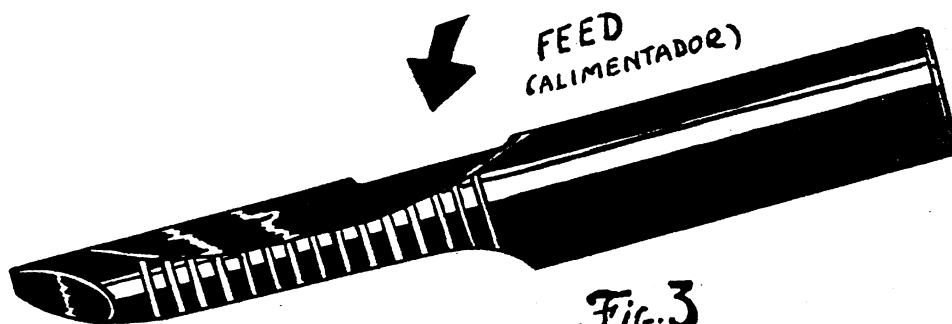

Fig. 3

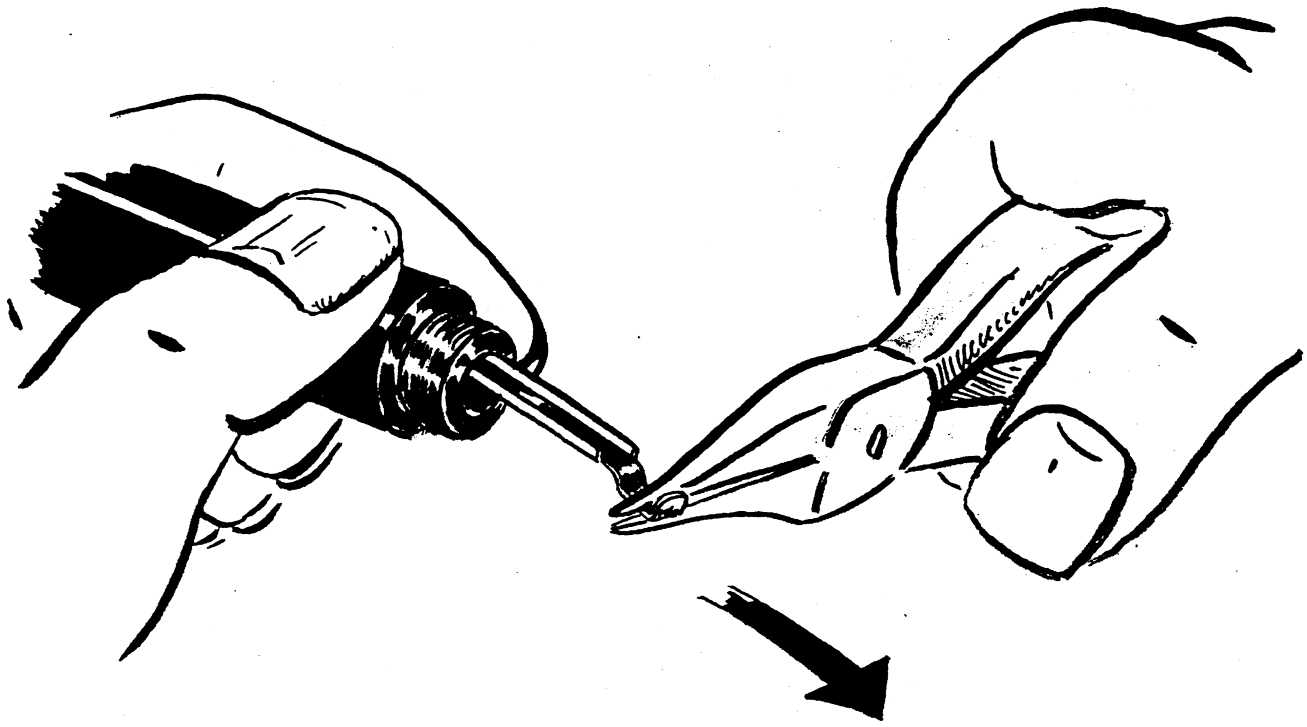

Fig. 4

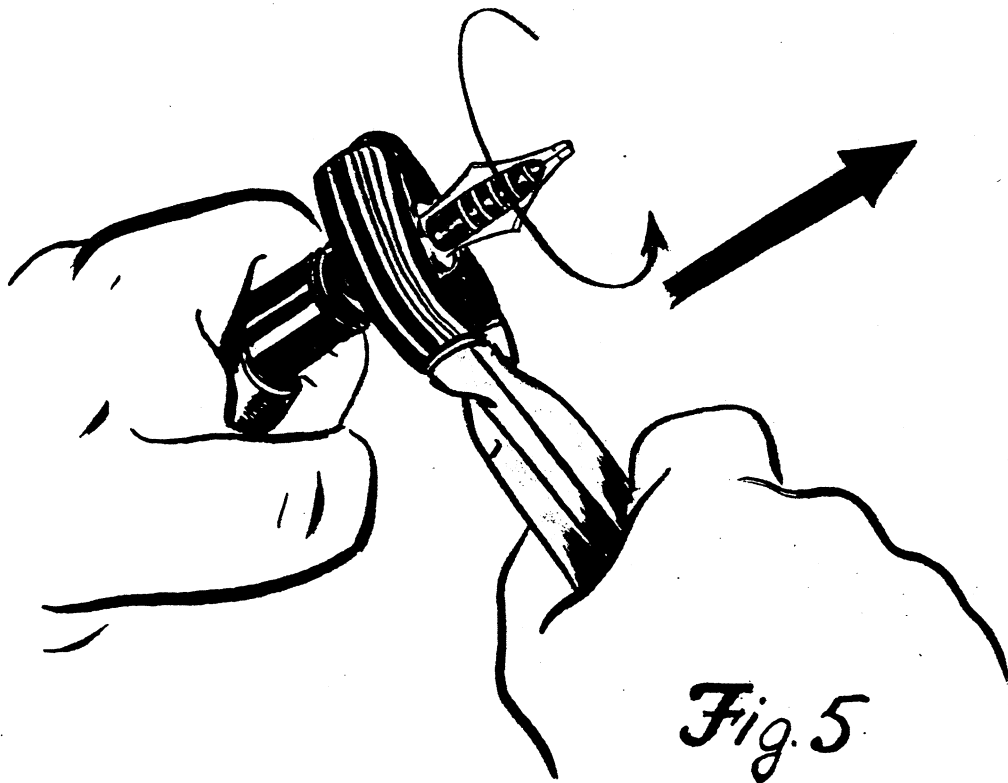

Fig. 5

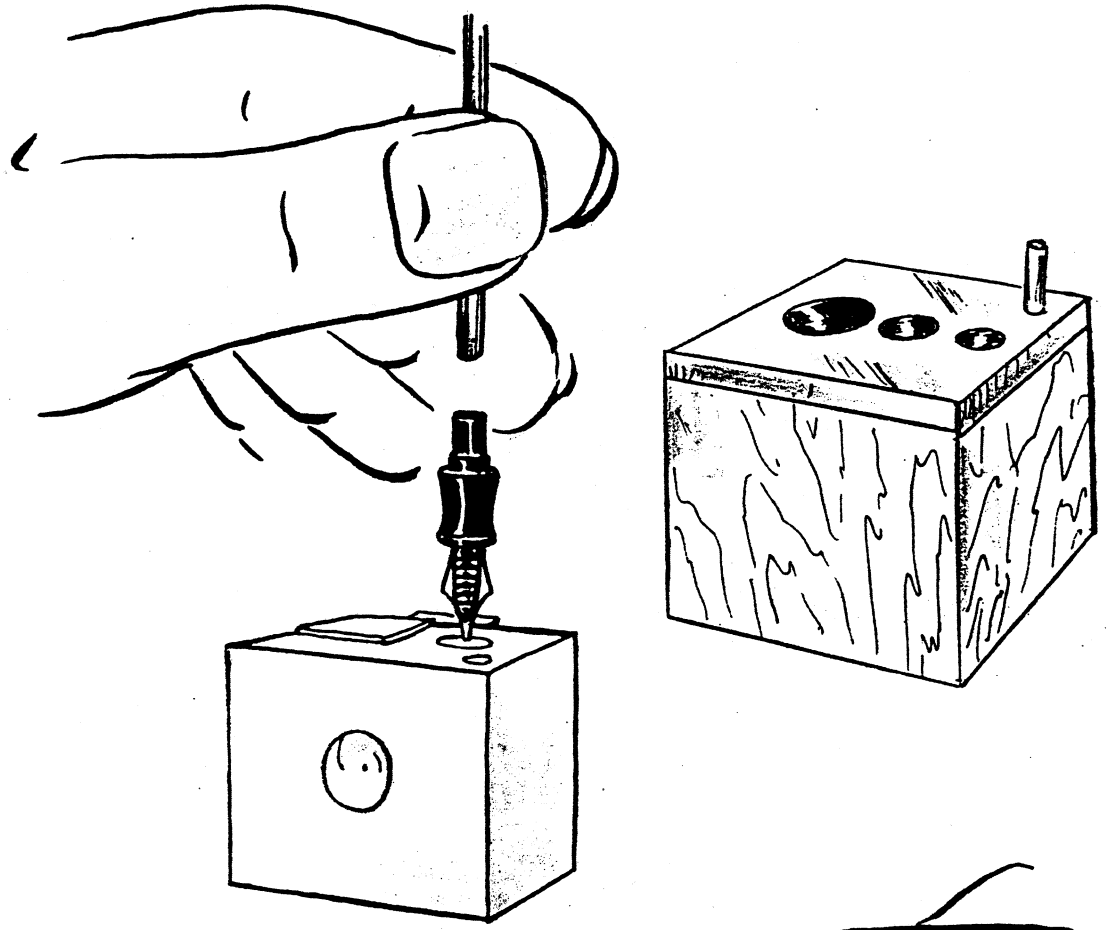
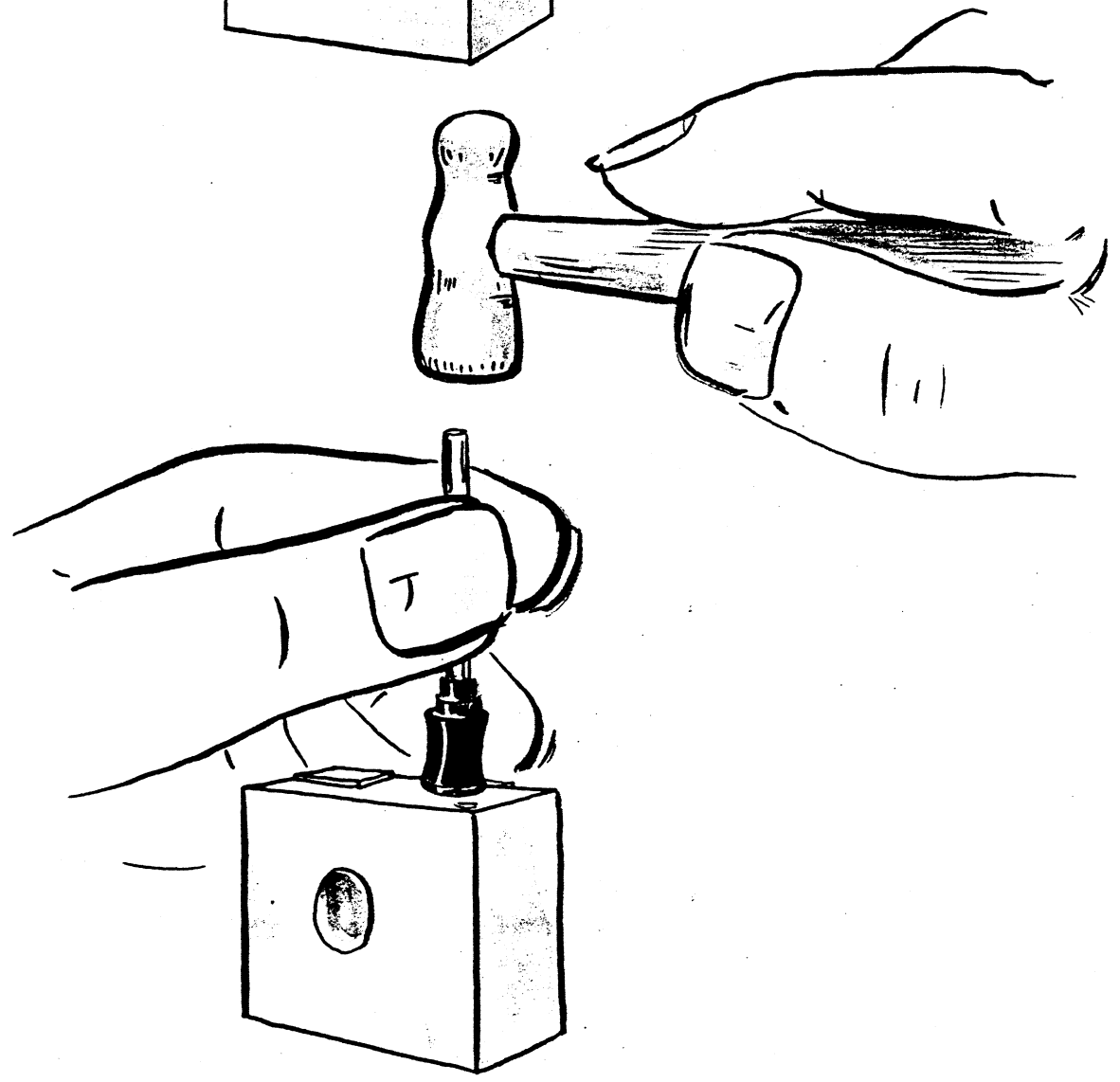

Fig. 6



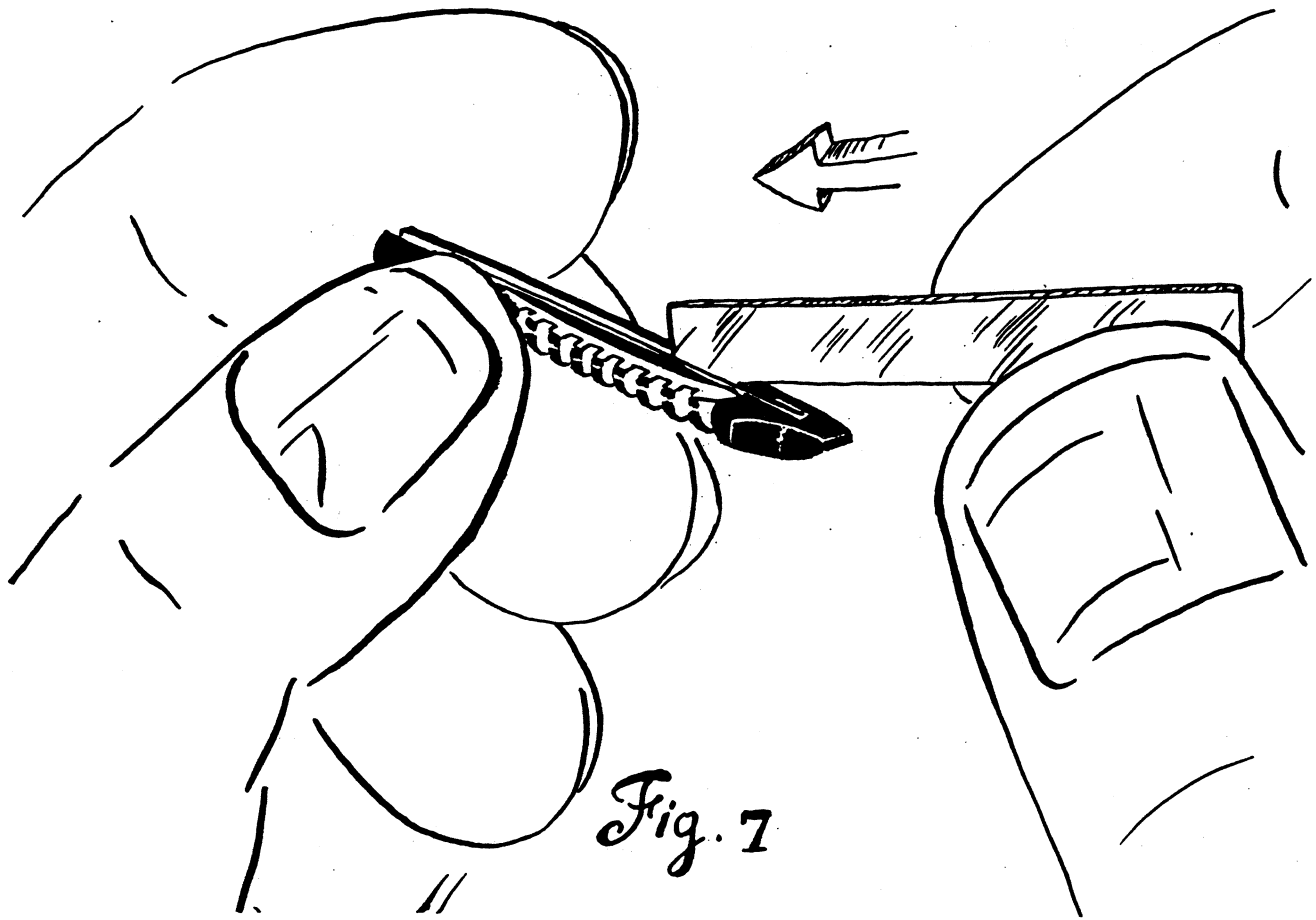

Fig. 7

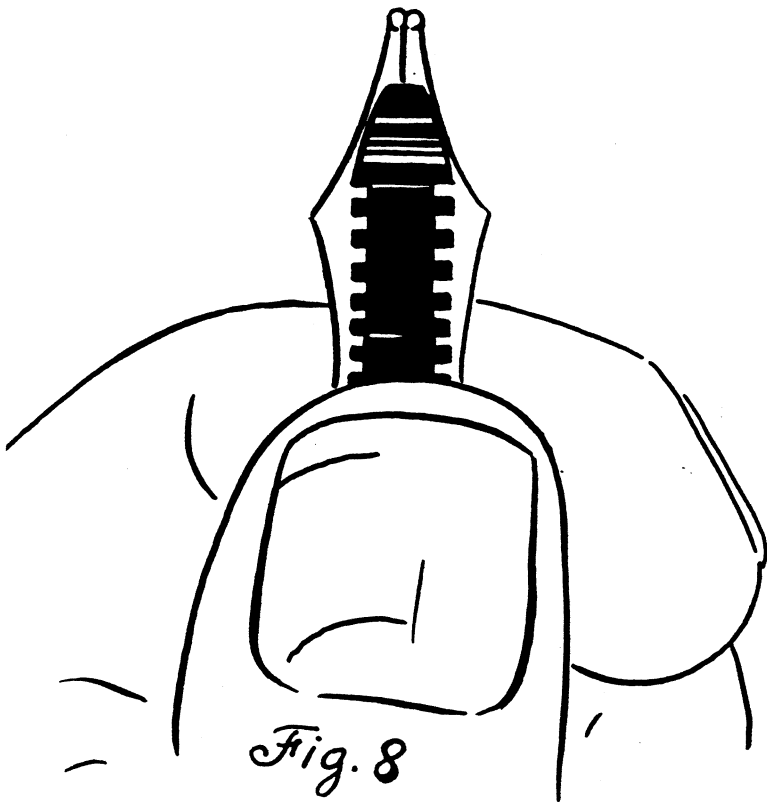

Fig. 8

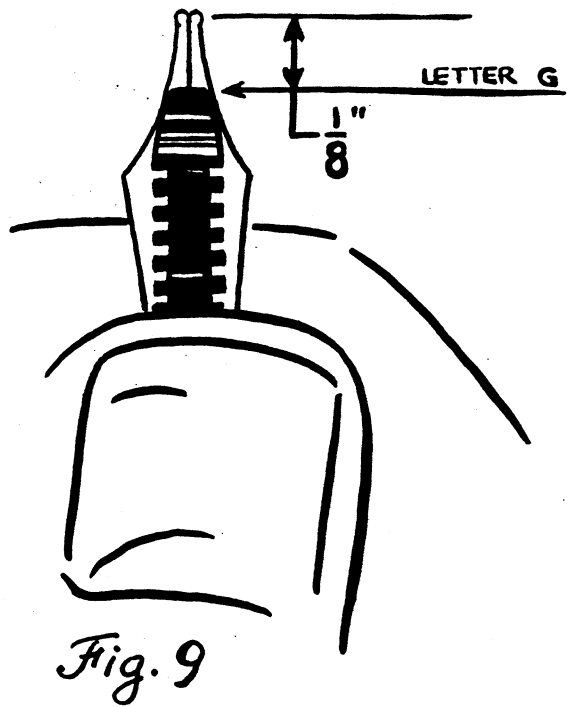

Fig. 9

If the feed has been warped or distorted dimensionally, it may be restored to its original contour by passing it across the tip of the flame of your alcohol burner. CAUTION: The feed and pyralin section are inflammable.

Check the nib carefully to see that it is not cracked or bent beyond straightening and make sure the pellet on the writing surface is not porous, cracked or chipped. (Special note: it is not necessary to adjust or align the nib prior to assembling the pen. Any adjustment in this respect may be done after the pen has been assembled.)

The barrel and cap assembly, section, blind cap and pressure button must be carefully inspected to make sure they are in good condition.

If the pressure bar is distorted, it must be exchanged to prevent the pen from leaking. There is no practical way of repairing a pressure bar which has become distorted.

Most service stations install a new sac in each pen they service. The sac should be sufficiently long to assure a generous ink capacity, yet short enough so that the pressure bar can easily clear the end of the sac. Suggested sac dimensions for each pen are as follows:

<u>Model of Pen</u>	<u>Inches</u>	<u>M.M.</u>	<u>Diameter</u> <u>M.M.</u>
Senior	2 1/2	63	9
Special	2 1/2	63	8
Long	2 1/2	63	7
Intermediate	2 1/4	57	8
Short, Junior	2	51	8
Lady	2	51	7
Pastel	2	51	6
Midget	1 1/2	37	7

To assemble the nib and feed into the section, place the nib and feed between the thumb and forefinger of your left hand. Figure 8.

Align the nib and feed carefully so that the slit in the nib bisects the tip of the feed. The feed must support both prongs of the nib equally. Align the feed so that it lies level in the nib and so that the extension of the tip of the nib beyond the tip of the feed falls within the tolerances $3/32'' - 1/8''$. Figure 9. This can easily be determined by use of the No. 9601 Brass Fitting Gauge in the following manner: After inverting the nib and feed so that the nib is uppermost, place the feed on the gauge so that its tip touches the bottom of the gauge. If the nib extension is correct, the tip of the nib will fall midway between the two lines marked on the base of the gauge. The tip of the nib may extend as long as the top line and as short as the bottom line, not over or under these lines.

Hold the nib and feed tightly in your left hand to prevent any shift of position, and insert them straight into the rubber-protected jaws of the Bernard pliers to about one-half their length and grip the nib and feed firmly. Make sure that the nib and feed are in line with the jaws of the pliers. Figure 10.

Next, hold the section in your left hand and place the nipple end of the section flat against the edge of your repair bench. Insert the back end of the feed and nib into the front end of the section and with firm pressure, push them part way into the section. Figure 11. Release the partially assembled nib, feed and section

making sure the feed and nib have not slipped out of position. The slit in the nib must bisect the tip of the feed and the feed must lie level in the nib. Gauge the extension of the nib beyond the feed for proper tolerance.

Then fit the nib further into the section so that the prescribed extension of the nib beyond the section is obtained. In the case of the Junior Duofold pen, this distance should be $3/4$ " and can be measured on Fitting Gauge No. 9601 as shown in Figure 12. If in this gauging operation you discover that the extension of the nib beyond the section is larger than prescribed, reinsert the nib and feed into the Bernard pliers (holding them firmly in your left hand) and rest the handles of the pliers on your workbench. With the pliers in this position, the nib and feed may be driven further into the section by tapping gently with the flat side of the section pliers or with a leather or plastic covered hammer. Figure 13.

At the end of the manual on pages 73 and 74 you will find adjustment sheets for the assembly of the various models. The measurements shown should be carefully observed in every case.

The nib and feed must fit tightly in the section. If they can be moved with your finger, it will be necessary to supply a new feed and in some instances a new section. If the nib extends beyond the prescribed distance, it may be damaged by the cap.

The next step is to cement the sac to the nipple of the section with Shellac No. 491, using a paper clip to apply it uniformly around the nipple. With the Sac Spreader expand the open end of the sac and insert the nipple of the section. Figure 14. Make sure the sac fits tightly around the nipple and that it is aligned with the nib, feed and section.

Insert the sac into the barrel. If it is a threaded section, screw it in tightly with the aid of the section pliers. If it is a slip section, insert the nib and feed into the disassembly block and press straight down on the barrel. Apply Shellac No. 491 to the nipple of the section to obtain a perfect seal of the section and barrel.

It is a common practice in slip section pens to align the slit in the nib with any engraving on the barrel of the pen.

Insertion of the pressure bar into the barrel must be done very carefully to avoid collapsing of the rubber sac. This is illustrated in Figure 15.

This operation is simplified by use of the Pressure Bar Insertion Tool No. 10534. Insert this tool into the upper end of the pen and carefully slide it between the sac and barrel wall. Insert the pressure bar between the barrel and the tool. Once the tool is inserted, hold it in place within the barrel with your thumb nail and withdraw the pressure bar insertion tool from the barrel. Figure 16.

If the pen is a slip section pen and the triple bar is being used, be sure the small lip on the end of the triple bar is hooked over the end of the barrel. In the case of the single bar used in screw section pens, there will be no lip to hook over the end of the barrel and the bar should be fully inserted.

Insert the pressure button over the end of the pressure bar and straight into the barrel of the pen. If the pressure button fits too loosely it may be expanded by inserting a tapered object, such as a pencil point, into the open end of the button and flaring the four flanges.

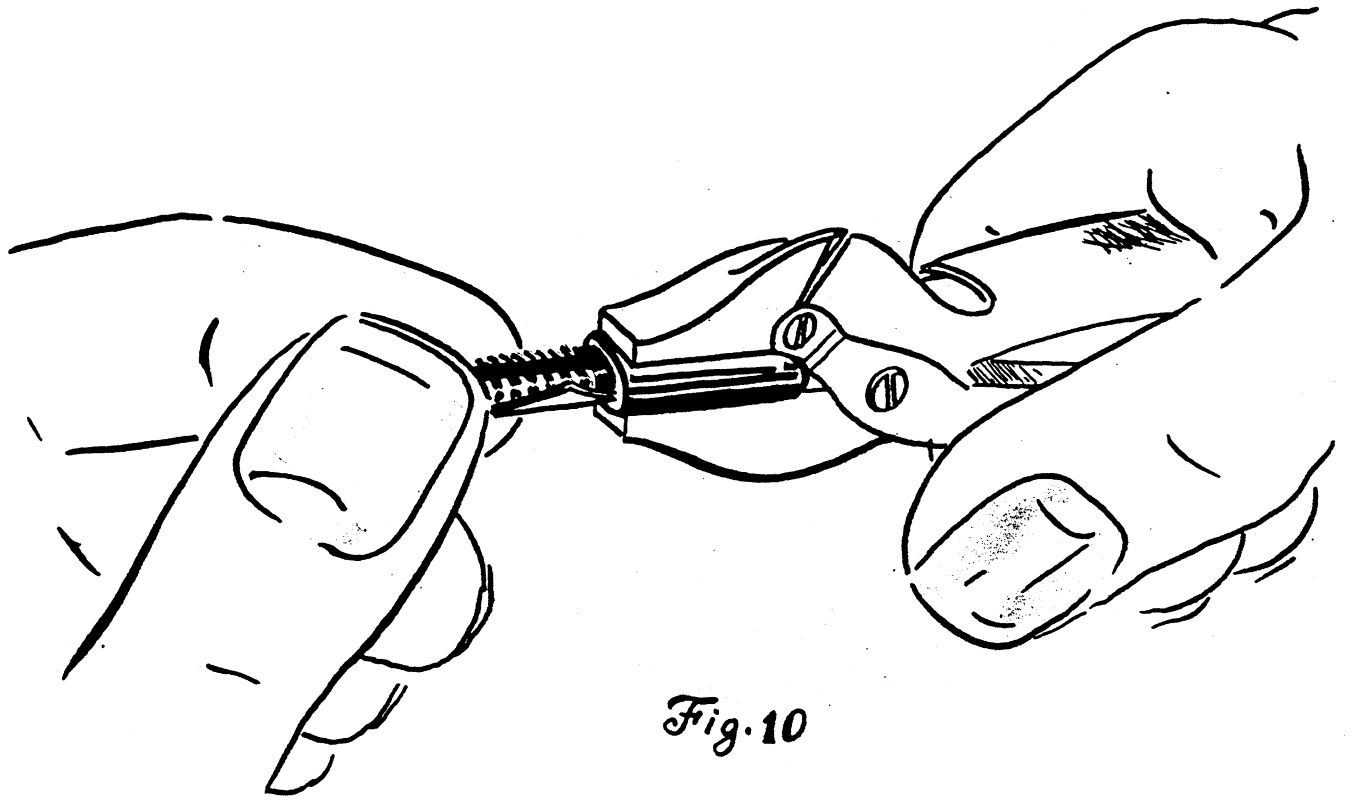

Fig. 10

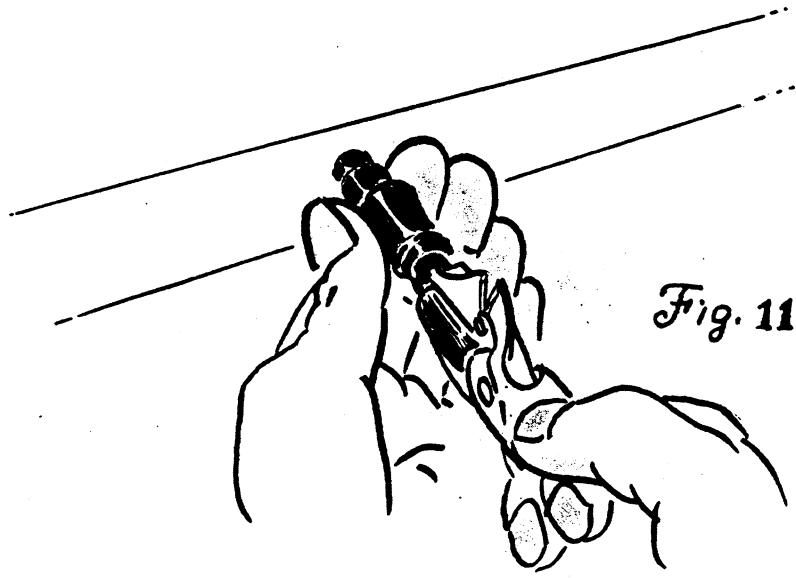

Fig. 11

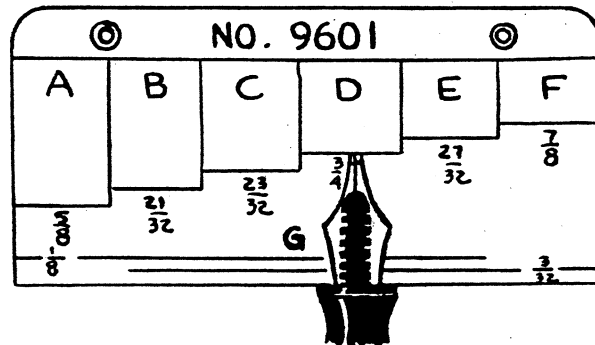

Fig. 12

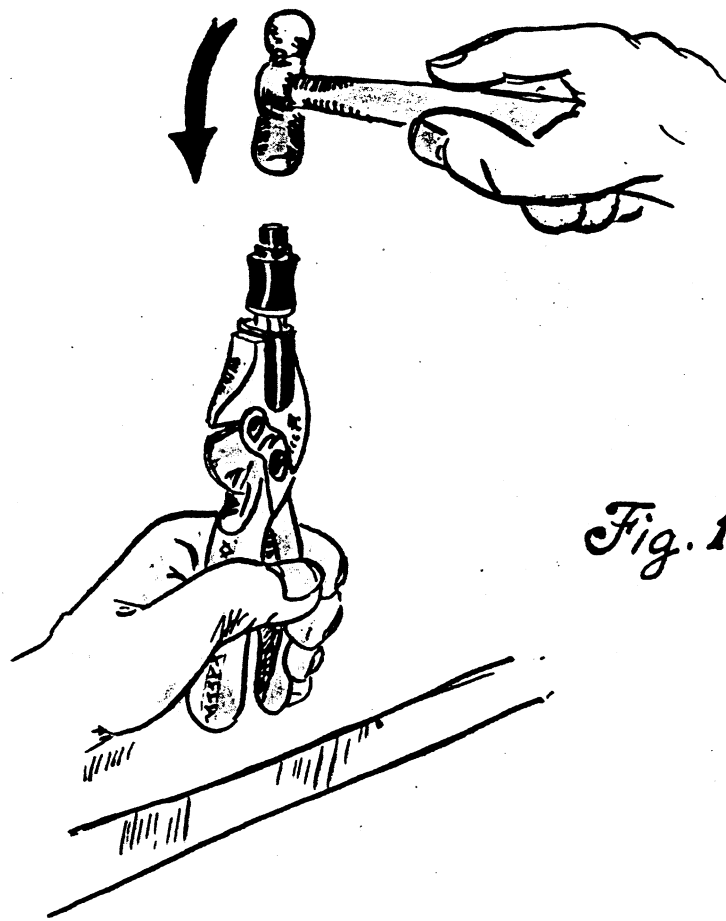

Fig. 13

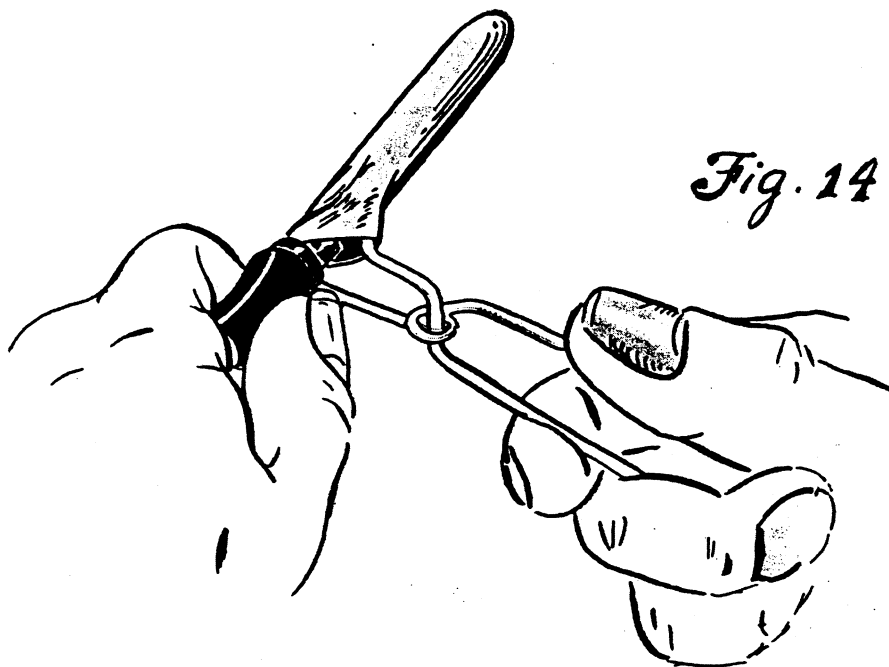

Fig. 14

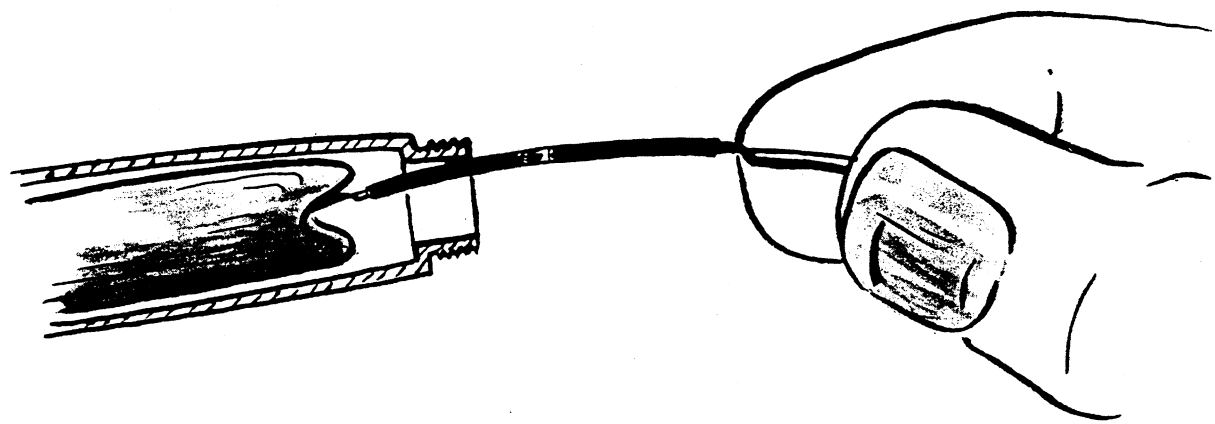

Fig. 15

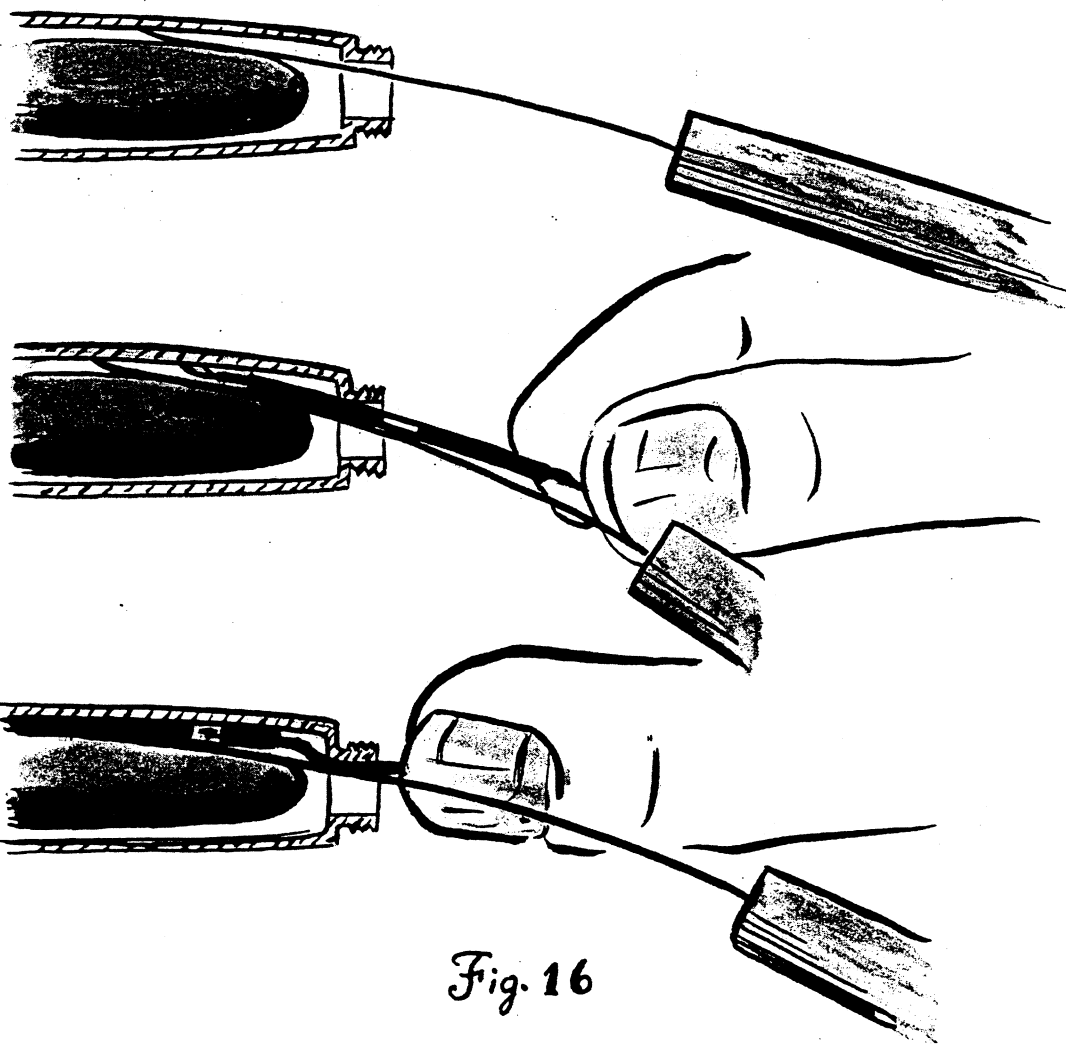

Fig. 16



Fig. 17

Hold the pen with the nib close to your ear and depress the pressure button. If properly assembled, you will hear the air as it is ejected from the section, feed and nib. CAUTION: Be sure that the pressure button does not press against the blind cap when this is screwed on the pen. Otherwise the pressure button will be partially depressed, causing the pen to leak. If so, remove the button, use your Bernard pliers to cut off a very small portion of the back end of the pressure bar. This will allow the button to seat down farther into the barrel of the pen.

The pen is now ready for nib adjustment.

NIB ADJUSTMENT AND SPACING

All nib spacing and adjustments should be made after the pen has been completely reassembled. The following procedures have been found to be most practical:

Nib Spacing - It is a fairly simple operation to increase or decrease the width of spacing in the channel of the nib.

When the channel of a nib is opened wider to increase the flow of ink, certain stresses and strains within the metal itself hold the nib in proper adjustment. Every nib that is fitted correctly into a pen has a slight "bow" or curve from its heel to its writing tip. Figure 17. Any pressure applied directly over the pierce in the nib tends to flatten out this "bow" and thereby separate the two prongs. Test this by holding the nib and feed of your Duofold pen between your forefinger and thumb and applying pressure directly across the pierce of the nib. As you apply this pressure, you can actually see the spacing in the nib increase. You cannot, however, exert enough pressure with your thumb and forefinger to change the stress in the nib itself and thereby produce a permanent increase in this spacing.

The following method can change the stresses in the nib to effect a permanent increase in the flow of ink. Lay the nib and feed on the edge of the table being careful to have the feed lie flat on the table's surface so it is supported evenly. Place the brass knockout rod crosswise over the nib and press it firmly on the pierce in the nib. Roll the rod back and forth. Figure 18. This operation permanently increases the spacing in the channel of the nib. Check with your magnifying glass and see the change in width of spacing. Varying pressures used in pressing down on the pierce of the nib will produce different degrees of flow increase.

To decrease the amount of spacing in the channel and to effect a permanent lessening of the flow of ink, you must change the stress in the metal of the nib to set the prongs of the nib closer together. This is accomplished by resting the side of one prong of the nib on the edge of your workbench. Support the pen with your right hand and use your left thumb to catch the corner of the upper prong and press over and down. Figure 19. This will cross the upper prong over the lower prong. When you release the pressure and examine the point, you will find that the spacing in the nib channel has been decreased. Rotate the entire pen in your right hand so that the opposite prong may be laid on the edge of the desk. Catch the corner of the gold nib with your left thumb, and this time pull over and down to cross the opposite prong. Figure 20. This step further decreases the spacing in the nib channel.

Nib Adjustment - After the nib has been spaced, make sure the prongs are perfectly aligned with each other. It is absolutely necessary to have these prongs perfectly in line at the writing surface in order to have smooth and steady writing.

Holding the pen by the section at an angle of 45° (as illustrated in Figure 21) with

the magnifying glass at approximately one inch from the pen you can examine the writing surface of the nib.

The two lower drawings in Figure 21 illustrate sprung nibs. If inspection of a nib shows that it is sprung, it is necessary to align the prongs by the following procedure. To lower or bend down a prong that is raised, carefully insert the nib pliers between the high prong and the feed. The nib pliers should be pushed back between the nib and feed until they intercept or "bite" the circumference of the pierce in the center of the nib. They should not be parallel to the slit in the nib. They should not be at a right angle to the slit in the nib. Rather, they should make a 10° or 15° angle to the slit in the nib.

Grasping the nib pliers tightly with one hand, support the pen barrel, nib and feed with the other hand; and with the nib pliers in proper position, gently bend the high prong straight down. Figure 22. A heavy, downward bend may put a kink or sharp bend in the gold nib itself. Do not twist the nib pliers as you bend down as this will flare the sides of the channel in the nib and create a defect commonly known as a "troughed nib". A nib is troughed when the sides of the slit are not parallel to each other.

If two or three light, bending adjustments on the high prong fail to lower it sufficiently, insert the nib pliers in the same position under the low prong and raise it very gently.

Either of these adjustments to correct a sprung nib will also affect the width of spacing in the channel of the nib, and consequently will also affect the flow of ink. If a high prong is bent slightly downward to secure proper alignment, the width of spacing in the channel of the nib will be decreased. If a low prong is bent slightly upward to secure alignment, the width of the spacing will be increased.

Bending either prong of a nib upward may raise that prong to such a degree that it no longer is in actual contact with the tip of the feed. Figure 23. To quickly determine whether the prongs are in good contact with the tip of the feed, take an ordinary sheet of writing paper and attempt to insert it between the nib and the feed tip. If the paper slides between the tip of the feed and the prongs of the nib, the prongs are raised too far. The feed must then be heated and molded up to the prongs. To accomplish this, pass approximately $1/4$ " of the tip of the feed back and forth through the flame of your alcohol burner. Heat the tip of the feed until it is fairly warm, being careful not to burn it by leaving it in the flame more than an instant. Figure 24. While the feed tip is still warm, lay the nib at an angle on the edge of your workbench and roll the brass knock-out rod over the flat under-surface of the feed tip. Figure 25. If you dip the rod in cold water before you mold the feed, the water will cool and harden the feed more quickly, thereby making this heating and molding operation easier.

Check again with a sheet of writing paper to make sure the feed tip is in contact with the prongs.

If a nib has become troughed in the channel (Figure 26) this condition must be corrected, or an excessive or erratic flow of ink may result. To correct it, insert the nib pliers between the nib and feed so that they extend back to the pierce, and so they are parallel to the slit in the nib. Using a wrist motion only, gently bend and flare the nib towards the center of the trough so the top of the trough in the slit is brought closer together. Figure 27.

As a final inspection after the nib has been properly spaced and adjusted, tap the

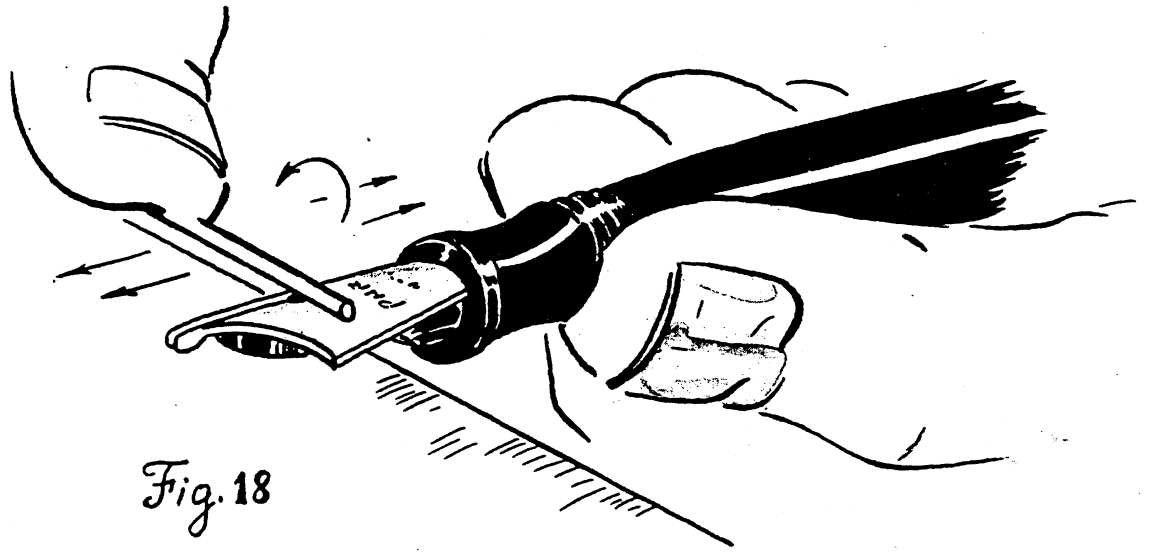

Fig. 18

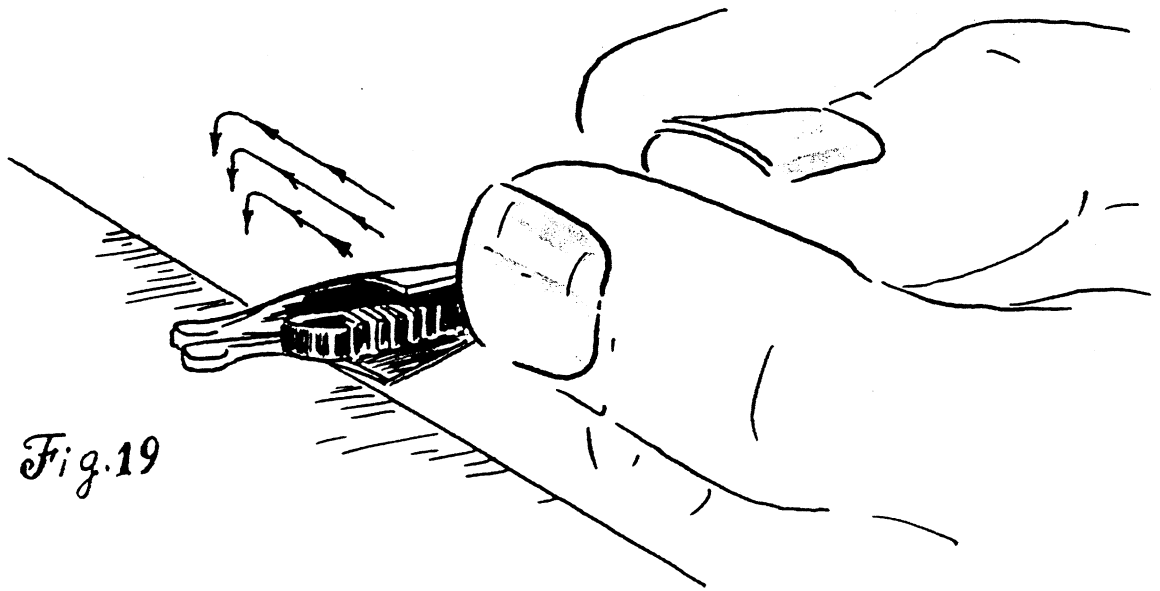

Fig. 19

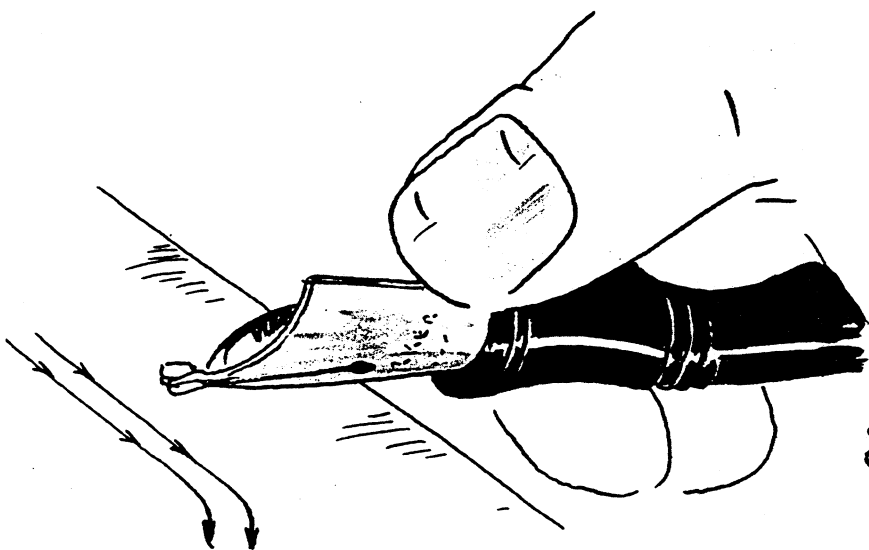

Fig. 20

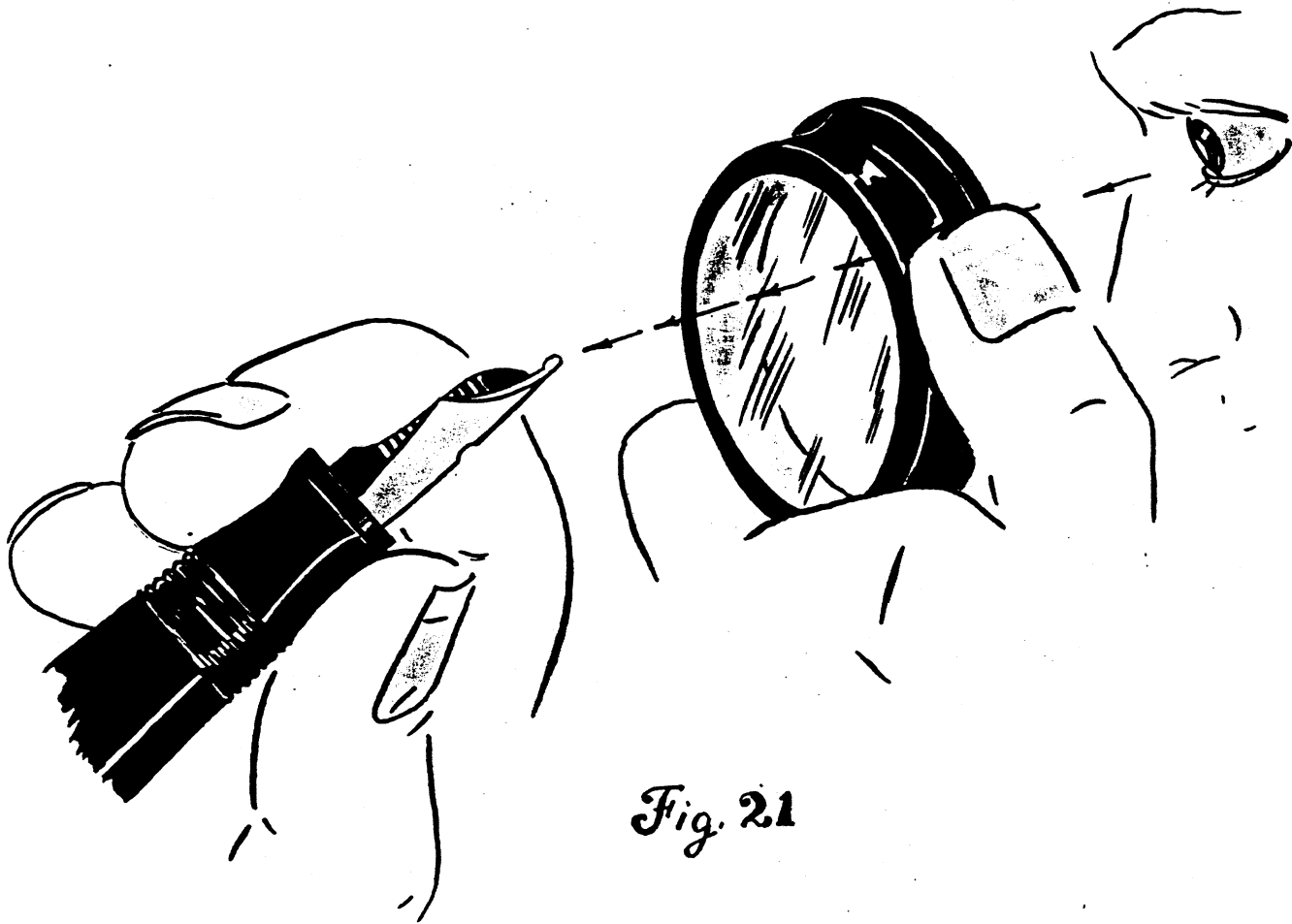
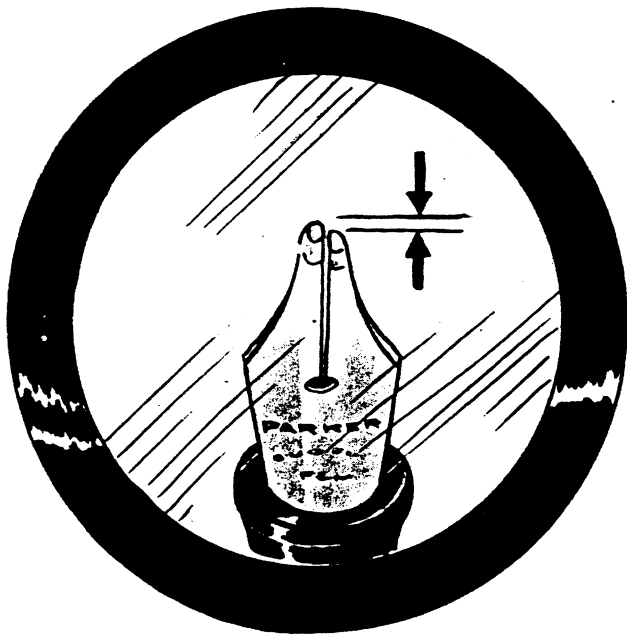

Fig. 21



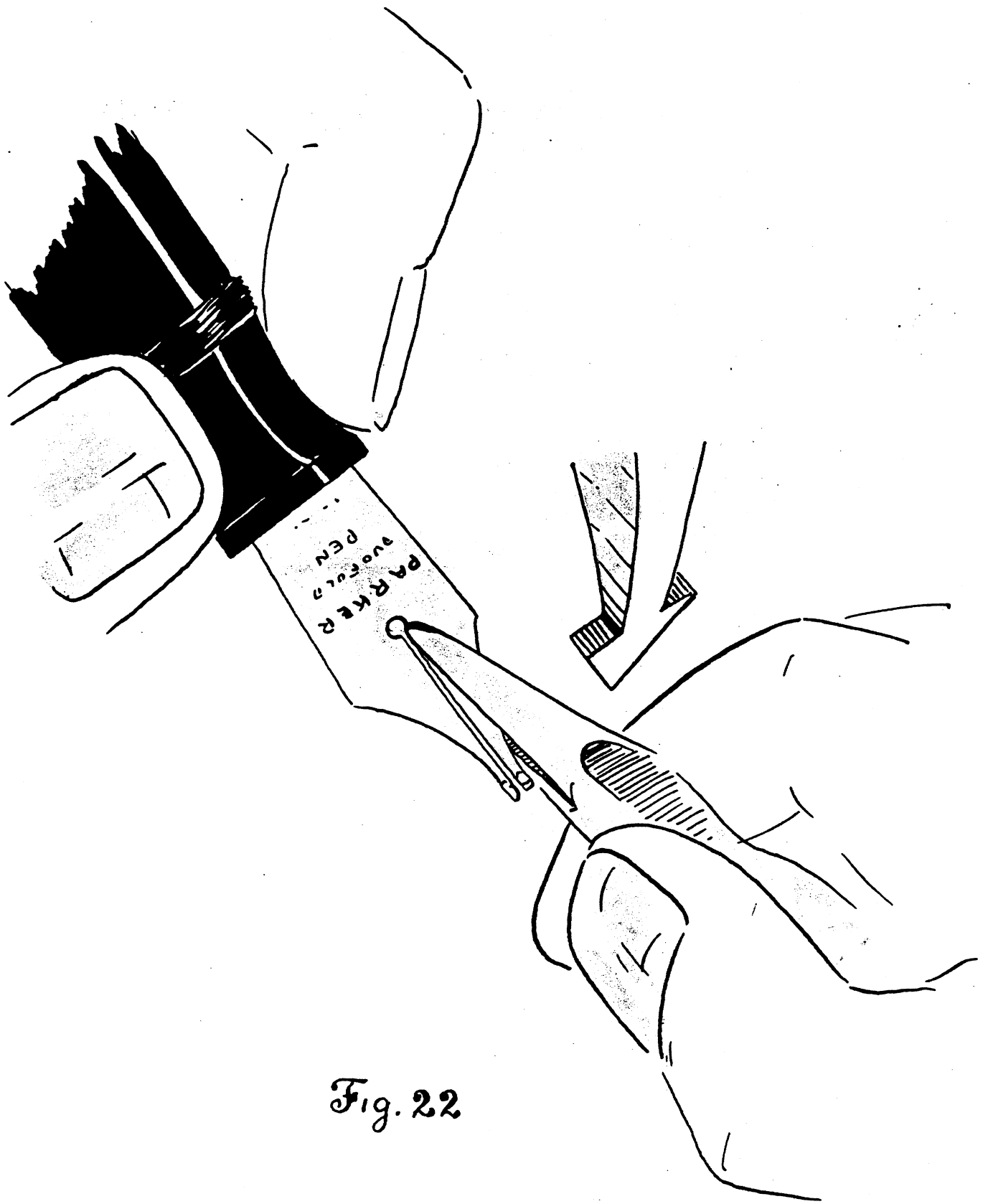

Fig. 22

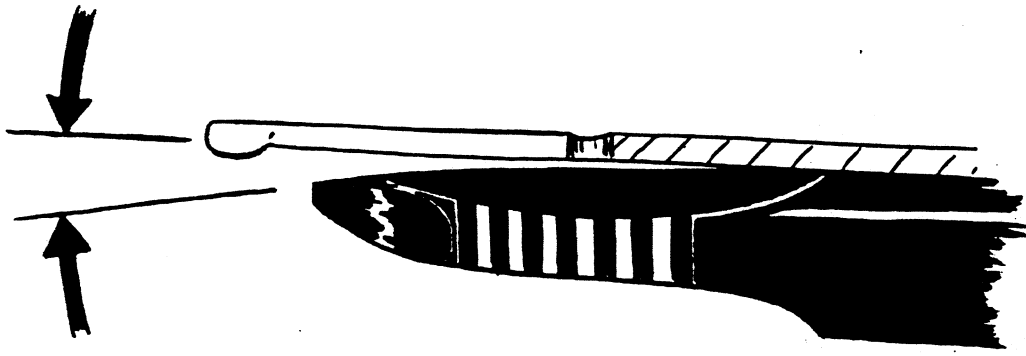

Fig. 23

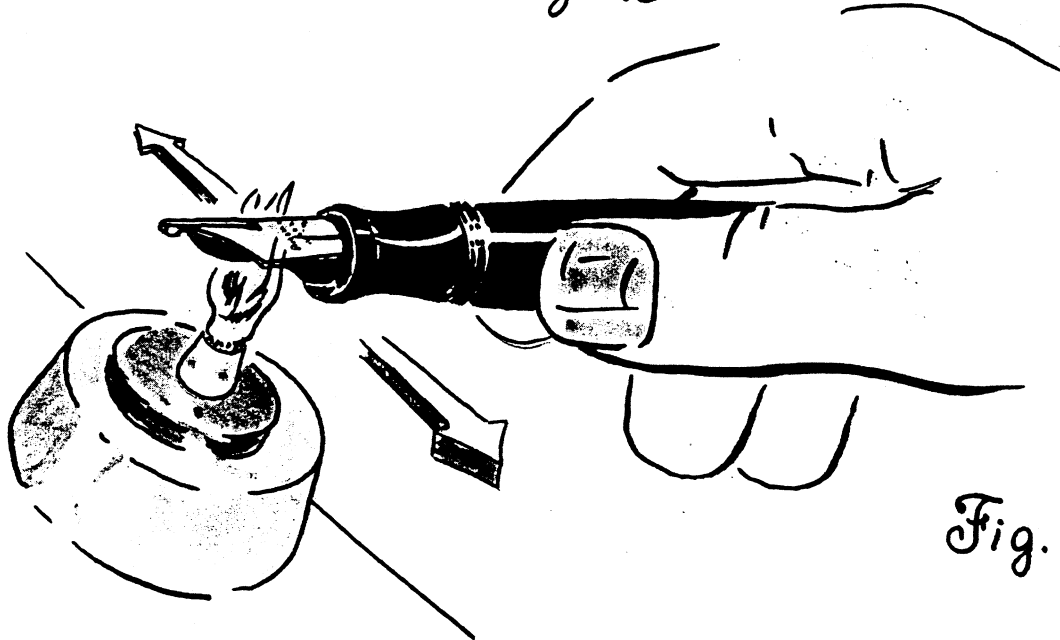

Fig. 24

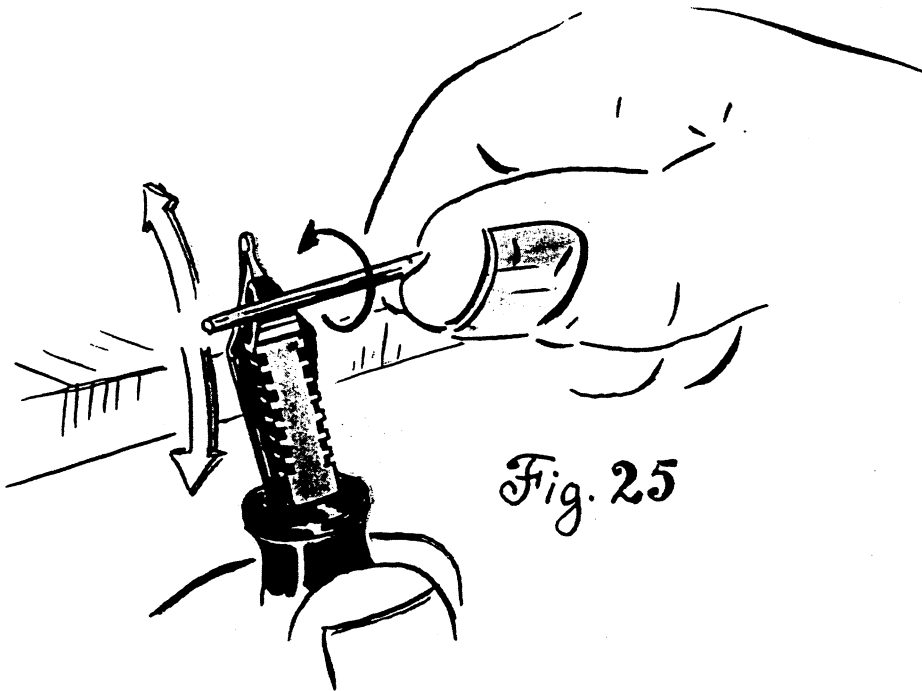

Fig. 25

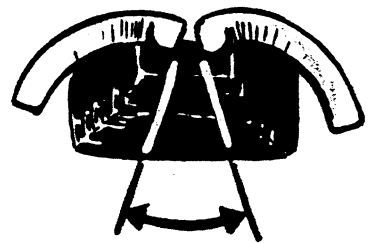

Fig. 26

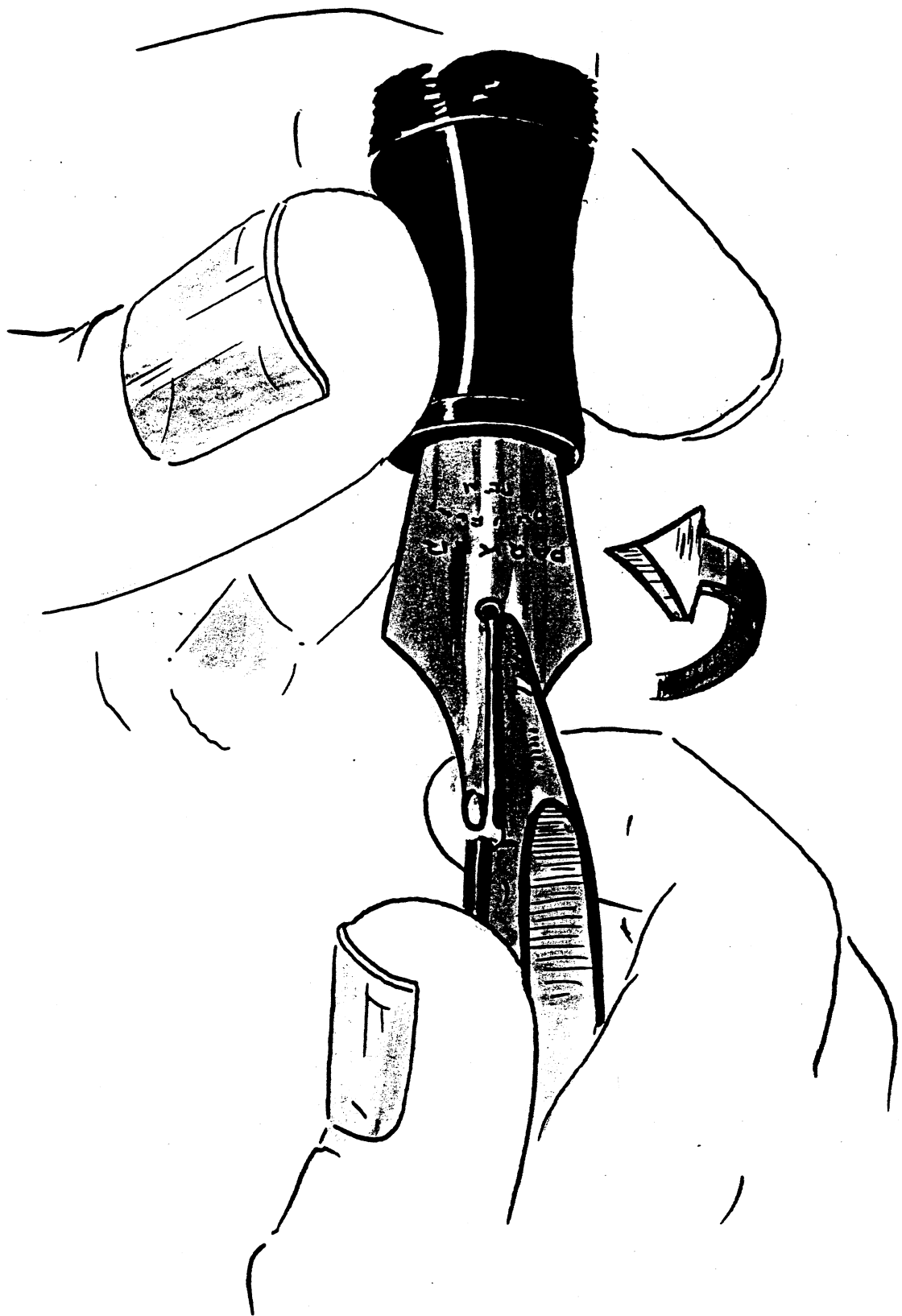
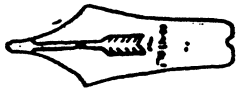

Fig. 27



NIB
(PLUMILLA)



FEED AND
BREATHER TUBE
(ALIMENTADOR Y TUBO RESPIRADOR)



SECTION
(SECCION)



BARREL LESS FILLER
UNIT AND BLIND CAP
(CARON)



FILLER UNIT
(UNIDAD LLENADORA)



BLIND CAP
(TAPITA)



CLIP SCREW
(TORNILLO DEL SUJETADOR)



CLIP
(SUJETADOR)



CAP LESS CLIP
(TAPA SIN SUJETADOR)

Fig. 28

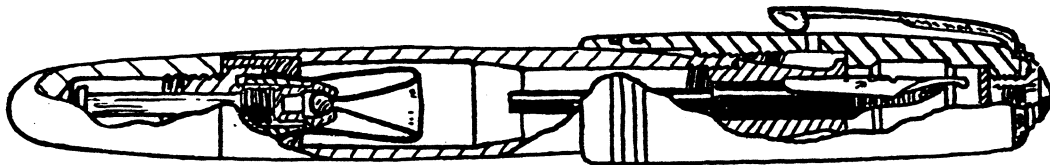

Fig. 29

back end of the pen on the bench or table top. Reinspect the prongs of the nib with your magnifying glass for alignment, possible troughed nib and proper spacing. Tapping the back end of the pen on the desk jars the prongs of the nib sufficiently so that they fall or revert to their final position.

Let us emphasize once again that inspection for a sprung point is most important of all. This should be the last inspection made before the pen is ready to return to its owner.

Spacing and adjusting nibs requires a delicate touch. Skill and proficiency in this operation are developed only after a great deal of practice.

PARKER VACUMATIC PENS

(Lock Type and Extended Type)

Several new principles were brought into play in the Vacumatic pens. The most important was that the reservoir was actually the barrel of the pen and not a sac inserted within the barrel. Figures 28 and 29. A new means of filling was devised whereby a simple recoiling diaphragm in the back end of the barrel ejected part of the air from the pen barrel with each downward stroke of the plunger. The feed in the pen was drilled to accommodate a breather tube. The top of the breather tube was open to internal pressure allowing air to be forced through the air hole in the feed, down through the wide channel in the feed, and escaped between the feed and the nib when the plunger was depressed. The pen became a multiple stroke filler (usually designated as a ten stroke filler). Figure 30.

The filling operation is quite simple. The nib is immersed in the ink and the plunger depressed briskly ten times, pausing at the top of each stroke. After the last downward stroke, the plunger is twisted in a clockwise direction to engage a small lock on the side of the metal plunger.

Each down stroke of the plunger creates internal pressure. Air is ejected through the breather tube into the ink bottle. Each up stroke of the plunger decreases the internal pressure. The external air pressure on the surface of the ink in the bottle forces ink into the pen through the wide channel in the feed and up through the breather tube. Each successive stroke pumps a little more air out of the pen and forces ink into the pen. When the level of ink within the pen barrel reaches the top of the breather tube, the filling cycle is completed.

In the Vacumatic pen there is not a separate inner cap within the outer cap. On the interior of the cap there is a machined ridge. When the outer cap is screwed on, this ridge sets against the section of the pen and forms the hermetic seal which maintains all pressures in a state of equilibrium. Figure 31.

All Vacumatic pens are equipped with a screw type section to preclude the possibility of leakage at the section and barrel joint.

The hard rubber feed of the Vacumatic pen has the same capillary cuts, wide channel cuts and cross cuts that the Duofold pen has. It has the same half-moon reservoirs and side cuts on the feed to control heavier than required surges of ink.

The Vacumatic pen clip is held in place by means of a clip screw and usually a clip screw bushing.

The later type of Vacumatic pen utilizes an "extended" filler unit. It does not lock

down on the last stroke. Instead, the plunger remains in the extended position after the pen is filled. Figure 32.

DISASSEMBLY

All Vacumatics are of screw section construction. To remove the section use a rubber pad to grasp the pen barrel with one hand, and with the other hand grip the section around the center by means of rubber-covered section pliers. Gripping the outer end of the section too tightly with the pliers may easily break it. With a quick snap or twist in a counter-clockwise direction, free the section and unscrew it from the pen barrel. CAUTION: The pen barrel may be full of ink.

After emptying the ink into a waste jar, check to be sure the blind cap is tightened over the filler unit. Then drop the entire barrel into cleaning solution for a few seconds. CAUTION: If the blind cap is not on tightly, cleaning fluid may penetrate the filler unit and start a corrosive action on its metal parts. Follow the cleaning bath with a cold water rinse.

You are now ready to disassemble the section, feed and nib. Place the nib and feed of the pen into the proper collar of the disassembly block and pull out the breather tube. Using the same procedure prescribed for the sac button-fill pen, drive the nib and feed out of the section. (Note: If you do not wish to remove the breather tube from the end of the feed, the knock-out rod will accommodate it by means of the drilled channel on one end.)

The filler unit should be carefully examined to determine whether or not it need be exchanged. A Vacumatic pen which has given trouble in filling should be examined carefully to make sure the breather tube is not plugged and also that the filler unit is in good operating condition.

It is advisable to exchange the filler when the following conditions are noted:

1. The filler unit does not operate properly and makes a "clucking" noise. In this category are those filler units which bind because of a swollen diaphragm and do not return to a normal position on the upstroke.
2. The filler unit is heavily corroded. This corrosion usually is a heavy white oxide on the steel spring which builds up on the plunger and may prevent movement of the plunger.
3. The filler unit obviously has a ruptured diaphragm. This is easily determined by the presence of ink on the plunger rod.

DISCOLORATION IN A PLUNGER ROD DOES NOT NECESSARILY MEAN THAT THE FILLER UNIT IS BAD AND MUST BE EXCHANGED. Many filler units with discolored plunger rods have been proved to be in perfect operating condition. The discoloration in many cases has been due to a slight aging of the plastic.

A tool known as the Filler Unit Tester No. 12039 has been developed to test filler units. It provides an accurate test for leakage of air through a ruptured filler unit diaphragm or through an imperfect filler unit installation.

The following instructions (if carefully carried out) will provide the repairman with a simple and yet effective means of testing Vacumatic type filler unit installations. Figure 33.

The tester consists of a rubber nest inserted into a brass arbor and a black rubber squeeze bulb which is slipped onto the end of the arbor to provide air pressure.

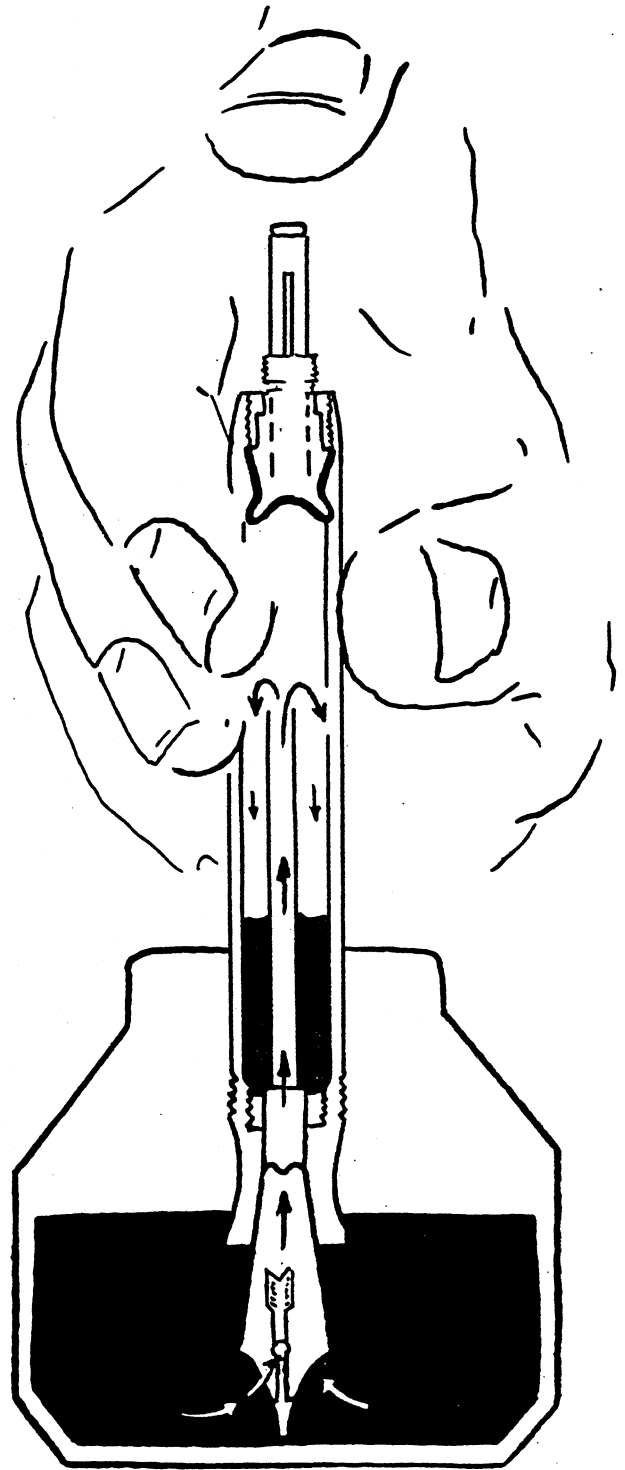
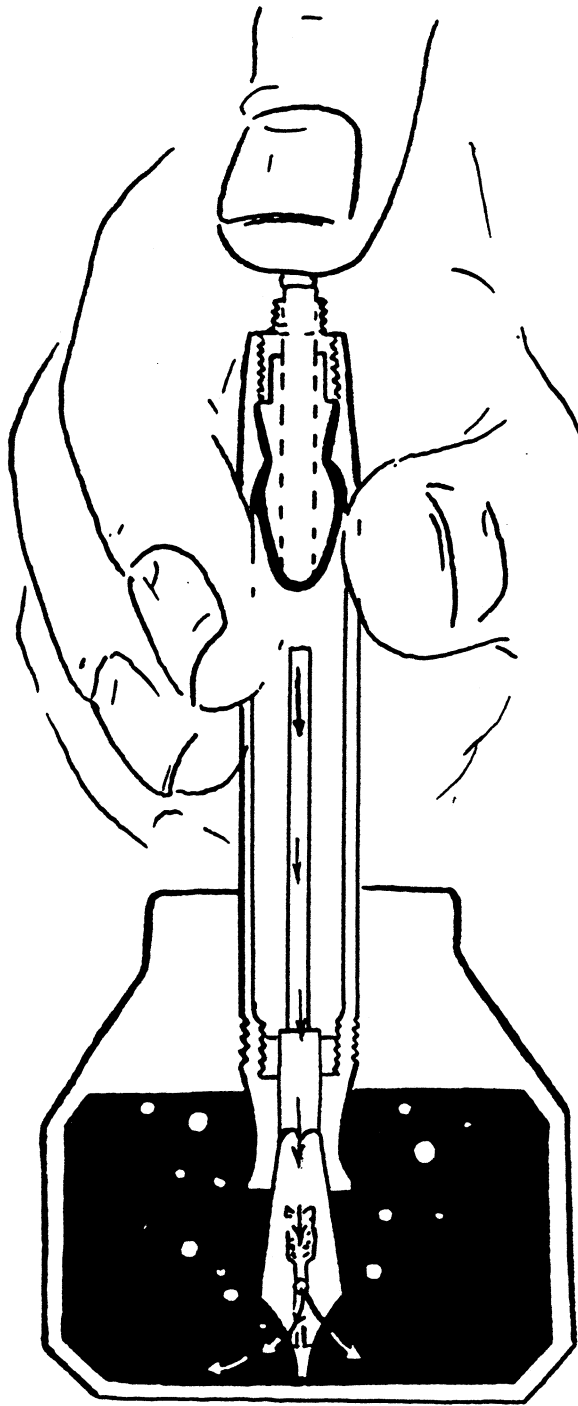

Fig. 30

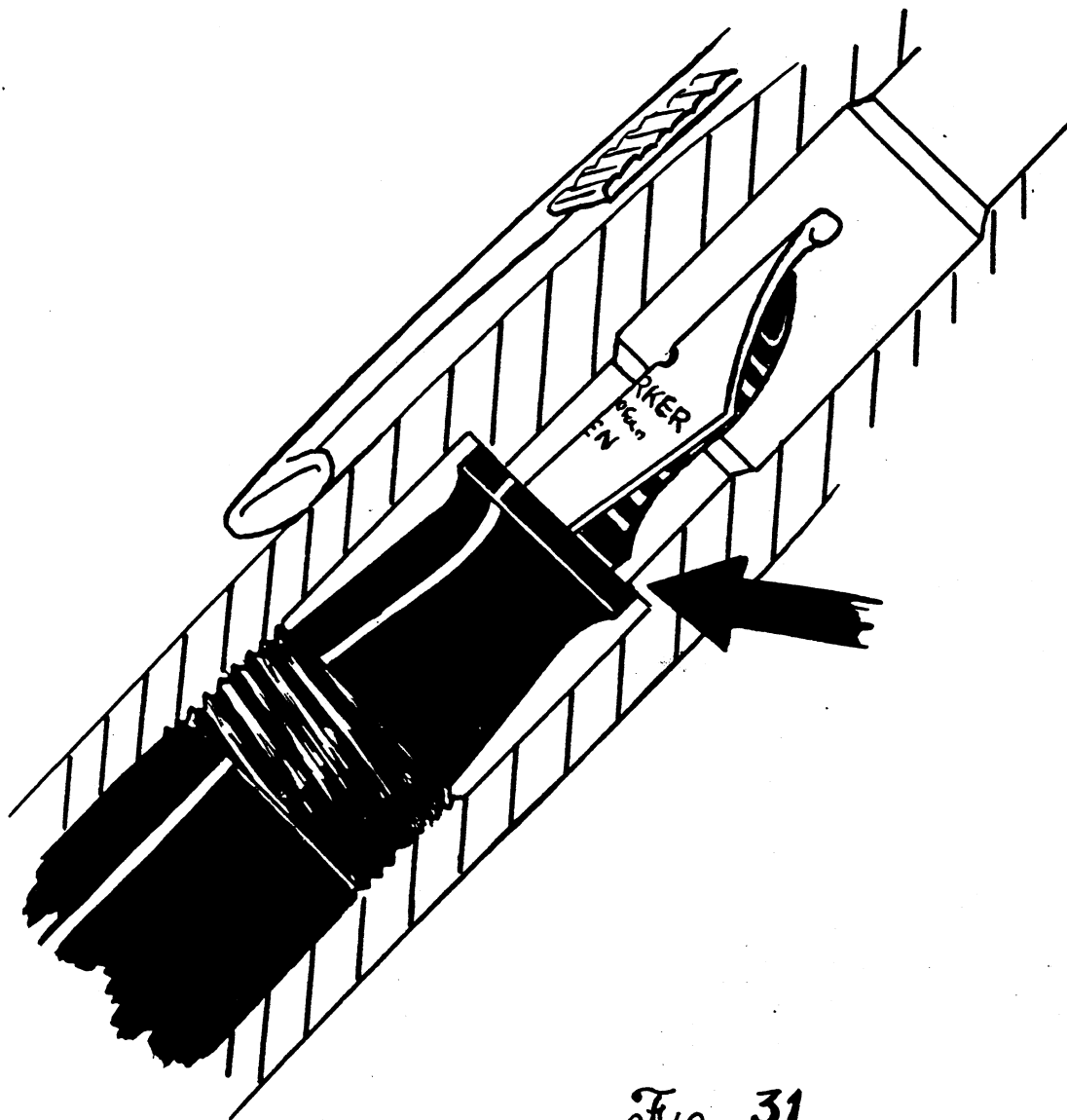
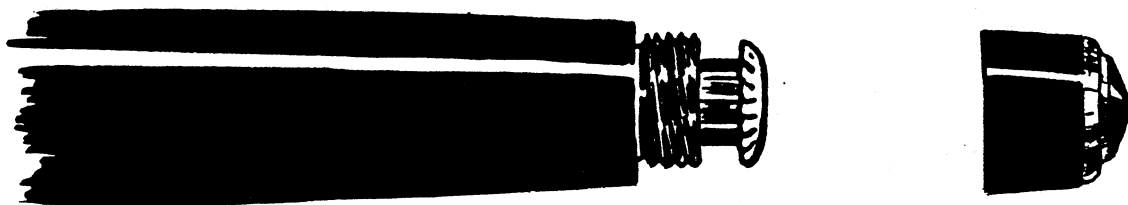
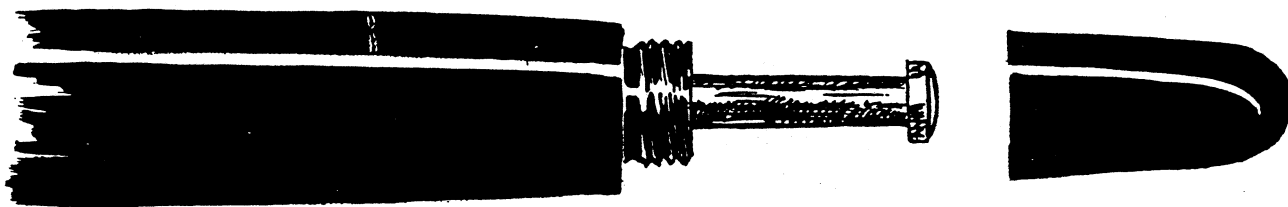

Fig. 31



LOCKED

Fig. 32



EXTENDED

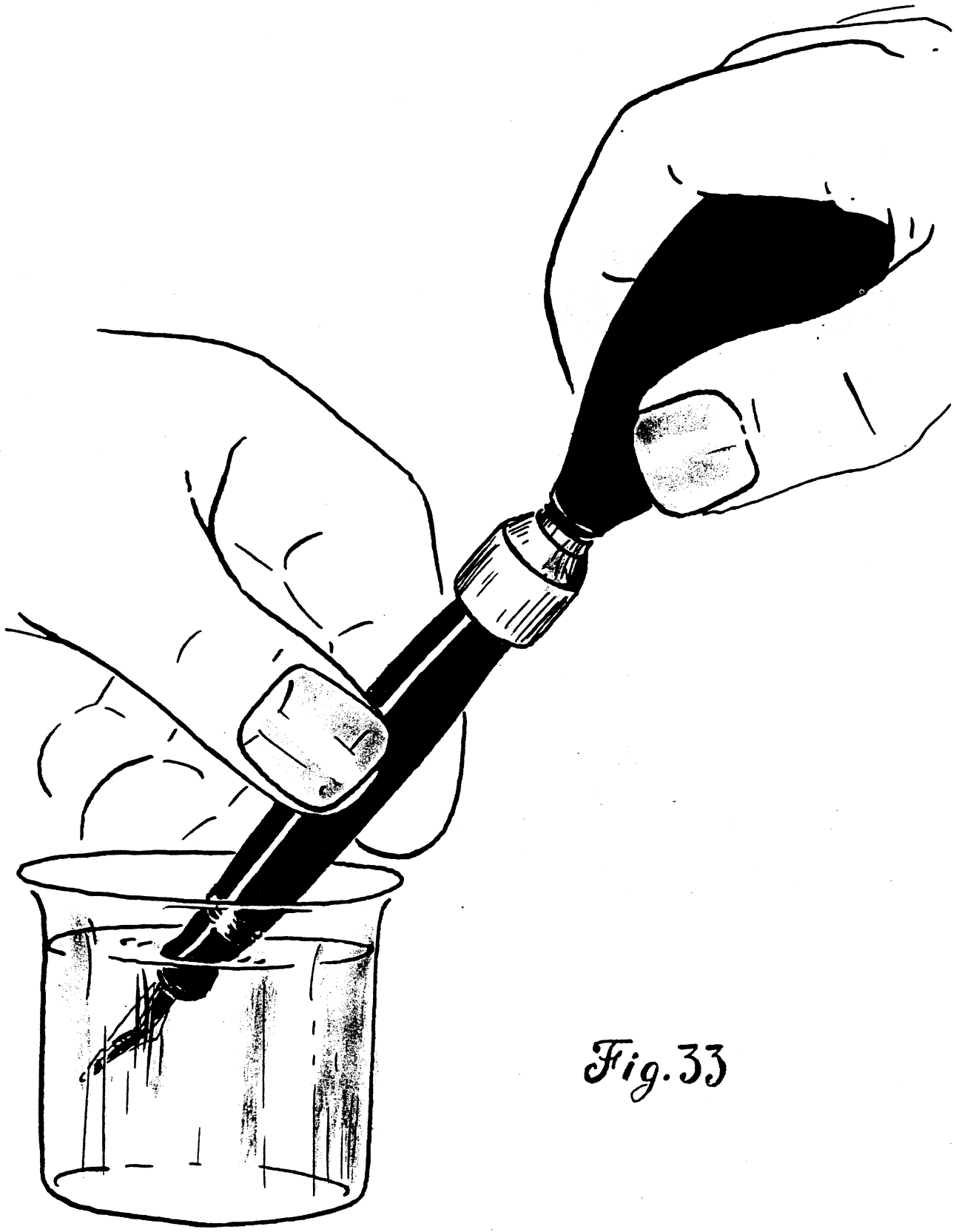

Fig. 33

This tester was designed for use on all Vacumatic type filler pens including all Vac-fil "51" and demi pens, all Vacumatic pens and all sacless Duofolds. Its purpose is to test for air leaks of any kind at the filler unit end of the pen. Instructions for using the tester are supplied with each tool.

If it is necessary to remove the filler unit from the barrel of the Parker Vacumatic, turn the top threads of the filler unit into the open end of the Filler Unit Wrench No. 8674 which is threaded to receive them. Grasp the wrench tightly in your right hand and squeeze the lever of this wrench down with your fingers to lock it securely on the filler unit threads. Grip the pen barrel in a rubber pad in your left hand, and with a quick twist or snap in a counter-clockwise direction turn the filler unit completely out of the barrel. Figure 34. After the threaded portion of the filler unit has been unscrewed from the barrel, the remainder of the unit may be pulled straight out.

If it has been necessary to disassemble the pen from the back end as well as to remove the section, a very thorough cleaning of the pen barrel can be accomplished by using the round bristle brush and scrubbing out the inside. Follow any chemical cleaning with a cold water rinse.

ASSEMBLY

Before attempting to reassemble any pen, carefully inspect each part to make sure that it is in working order. As recommended for other models, all parts (including nib, feed, section, barrel, etc.) should be carefully checked and cleaned.

Upon inspection of the writing surface of the pellet, you very frequently will find that the owner has worn a rather pronounced flat spot on this pellet. This is the result of the pen being held constantly in the same position over a period of many years. Such a spot does not mean that the nib is to be exchanged.

Make sure the feed channels, breather tube and air hole in the back of the feed are clear of obstructions. If they are clogged with sediment, air and ink cannot pass through them freely. As a result, the pen will not fill or write properly.

Inspect the barrel and the blind cap for cracks which may penetrate the interior of the barrel and make exchange of this part necessary.

Inspect the outer cap assembly. The air holes in the outer cap must be open; the clip must be down tight against the outer cap. If the clip is loose it will have to be removed and shaped into an arc-like contour over your thumb so it will fit smoothly.

If the old filler unit has been removed from the Vacumatic pen barrel, the barrel should be inspected at the filler unit end for the following details. Look for a small, tapered shoulder machined directly below the filler unit threads. Remove any old pieces of the neoprene diaphragm that might be stuck to this tapered shoulder. Figure 35. A small amount of lighter fluid poured into the back end of the barrel will help to soften these pieces if they are difficult to remove. After using this fluid, rinse the barrel in cold water.

The open end of the diaphragm on the new filler unit should be rolled back on itself and seated firmly to the shoulder on the metal coupling of the filler unit. Figure 36. Apply a small amount of Parker Diaphragm Lubricant (specification No. 188 with a paper clip or small brush to the outer surface of the diaphragm directly below the shoulder on the metal coupling. Figure 37. This lubricant will help the

diaphragm to seat properly on the tapered shoulder in the back end of the barrel. Grip the diaphragm directly over the metal coupling between your index and middle fingers, just as you would hold a cigarette. Depress the plunger with your thumb and extend the diaphragm. Insert the diaphragm straight into the back end of the pen barrel and release your two-finger grip. Figure 38. The diaphragm will then snap into position in the barrel and seat evenly on the tapered shoulder inside. Do not depress the plunger at this point; you might unseat the diaphragm.

Start the threaded connection of the filler unit into the barrel threads; then insert the top threads of the connection into your Filler Unit Wrench No. 8674. Clamp the wrench tightly in your hand and use a rubber pad in the other hand to tighten the filler unit into the barrel. Sometimes it will feel as though the filler unit is tight in the barrel when actually the wrench has contacted the back end of the barrel. To overcome this, release your grip on the filler unit wrench, back it off one or two turns, clamp down and tighten the filler into the barrel. A firm pressure should be used, but extreme pressure may cause a bulge to appear in the walls of the barrel.

Inspect the action of the filler unit after you have installed it. It should return to its full length on the release stroke. Check for smooth, easy action.

If a noticeable ridge appears at the joint between blind cap and barrel, it may be remedied by further tightening of the filler unit. As a rule, tightening the filler unit connection slightly will throw barrel and blind cap into better concentricity. For those blind cap joints which are unusually bad, it may be necessary to file or sand them down with a small file or a fine, wet strip of emery paper. Should this be necessary, restore the barrel to its original high lustre by using a buffing wheel and pumice or polish. Many shops use a small hand lathe to trim down off-center blind cap joints.

The back end of the pen is now completely reassembled. You may therefore proceed to reassemble and adjust the nib, feed and section following the instructions given for the sac button-fill pens in the first part of this manual.

Gauge the extension of the nib beyond the feed to the tolerances $3/32''$ - $1/8''$. The extension of the nib beyond the section on a Junior Vacumatic should be $3/4''$. Be sure the nib fits sufficiently tight so it will not move easily if you attempt to wiggle it back and forth with your fingers.

Reinsert the tapered end of the breather tube into the hole in the end of the feed. Without the breather tube the pen will not fill properly.

Apply a thin coating of Parker Vacumatic Cement (specification No. 569) to the threads of the section and screw the section into the front end of the barrel. Tighten the section firmly into the barrel with your section pliers. Do not tighten it too much as this may cause the threads on the end of the barrel to bulge and thus cause the cap of the pen to fit poorly.

Test the pen for filling action. Dip the nib below the surface of the ink and depress the plunger ten times, pausing at the top of each stroke. If the pen has been properly assembled, you will see the ink rise in the breather tube and run down the sides of the barrel each time you release the plunger. Ten strokes are usually sufficient to fill the average Vacumatic; however, in the Senior models some may require as many as twelve strokes. A simple rule to follow is: Continue the plunger strokes until air bubbles are no longer ejected into the ink.

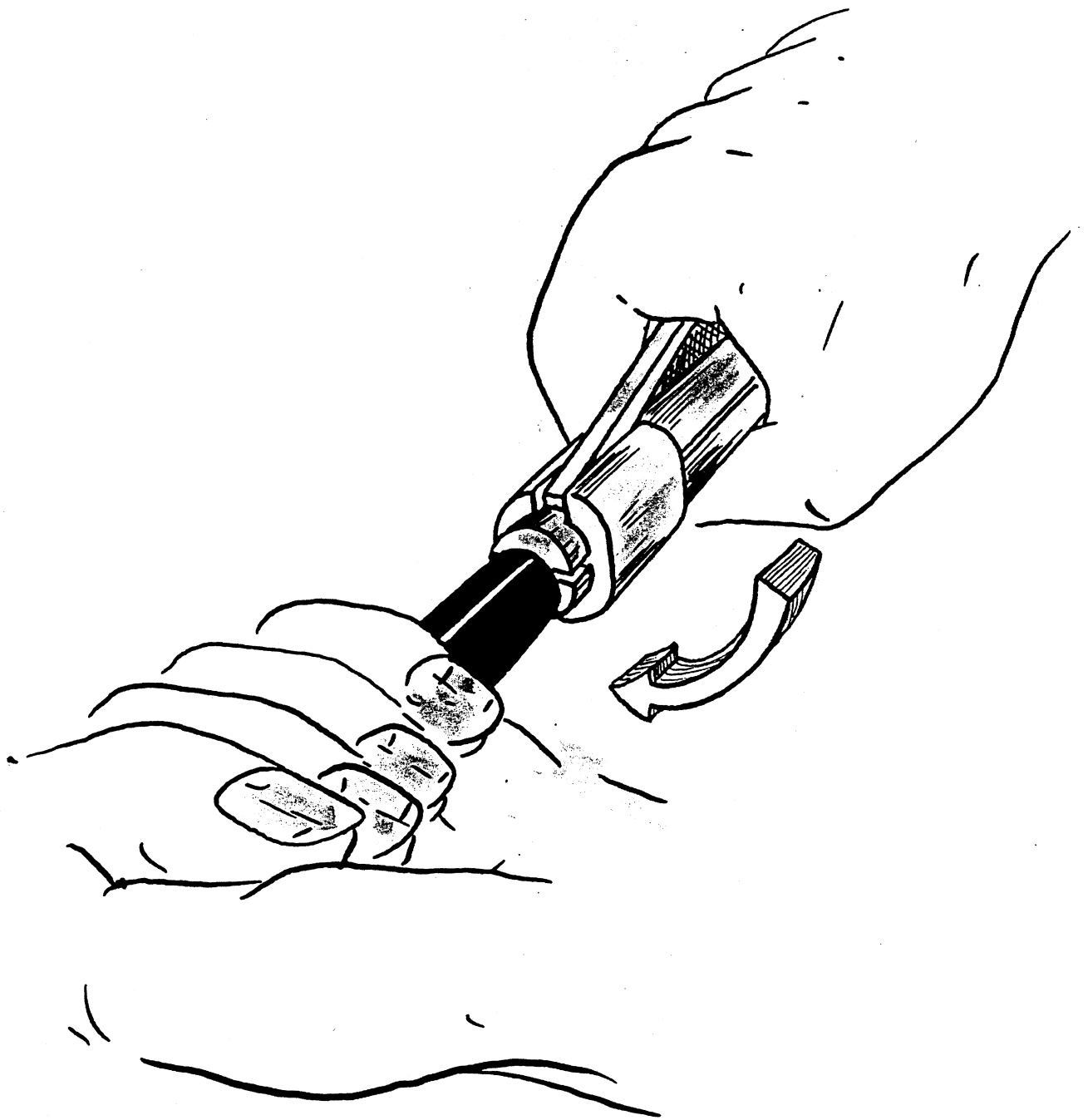

Fig. 34

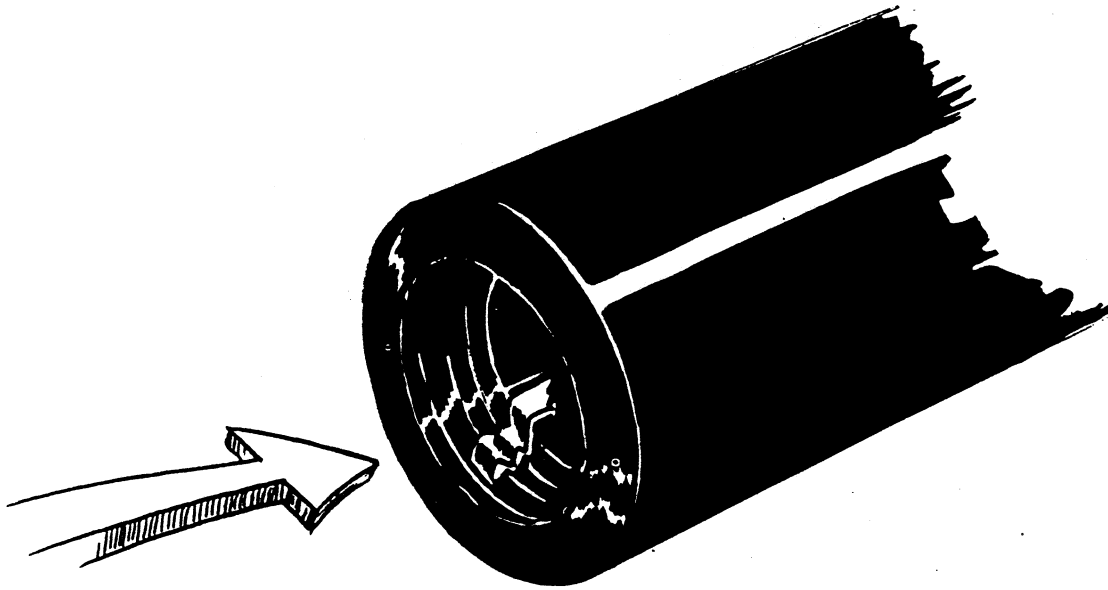

Fig. 35

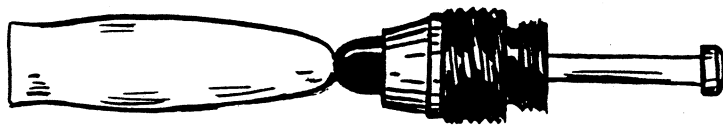

Fig. 36

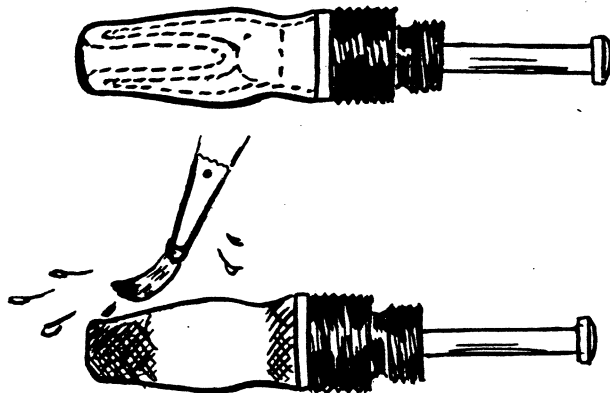

Fig. 37

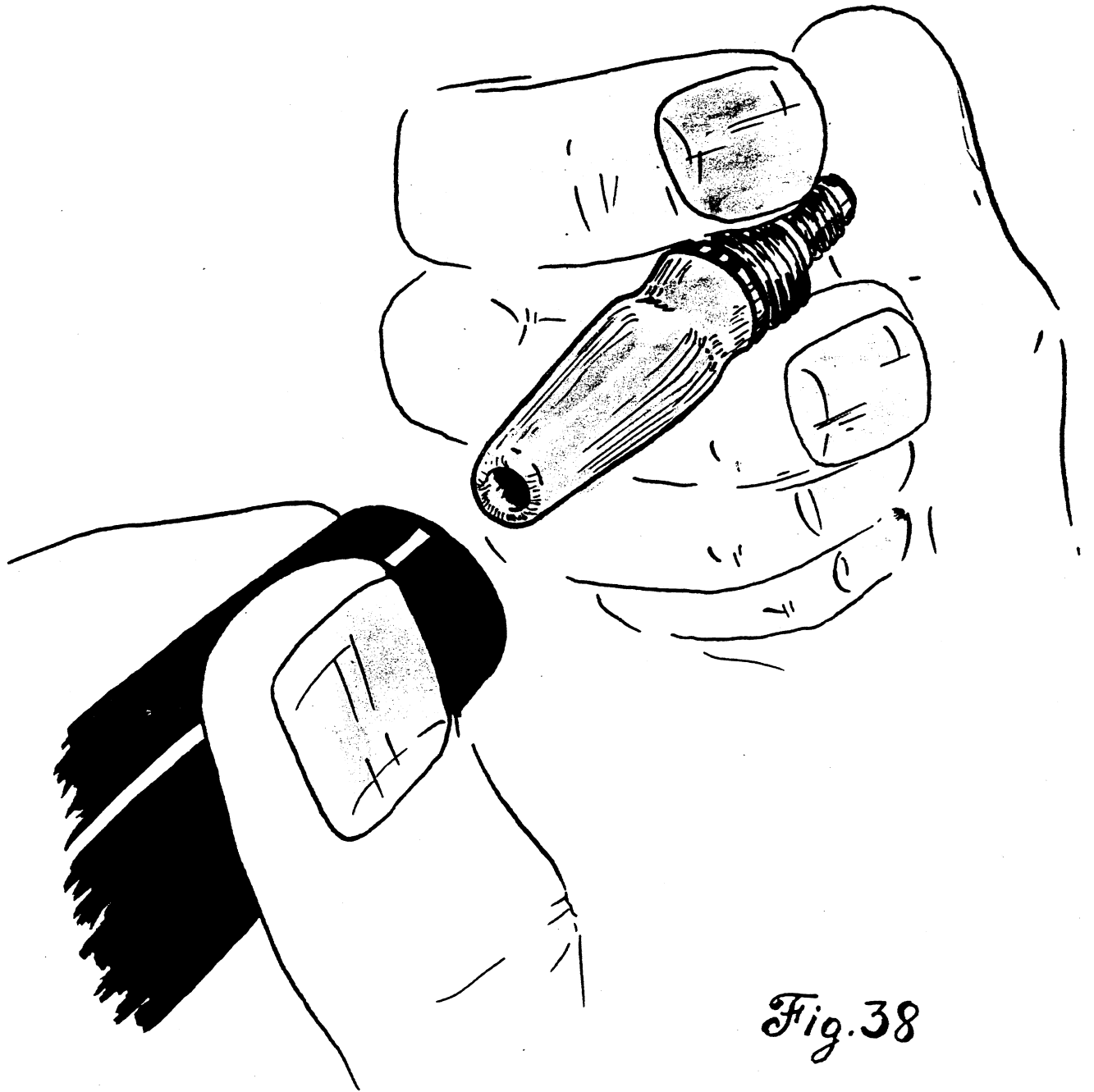

Fig. 38

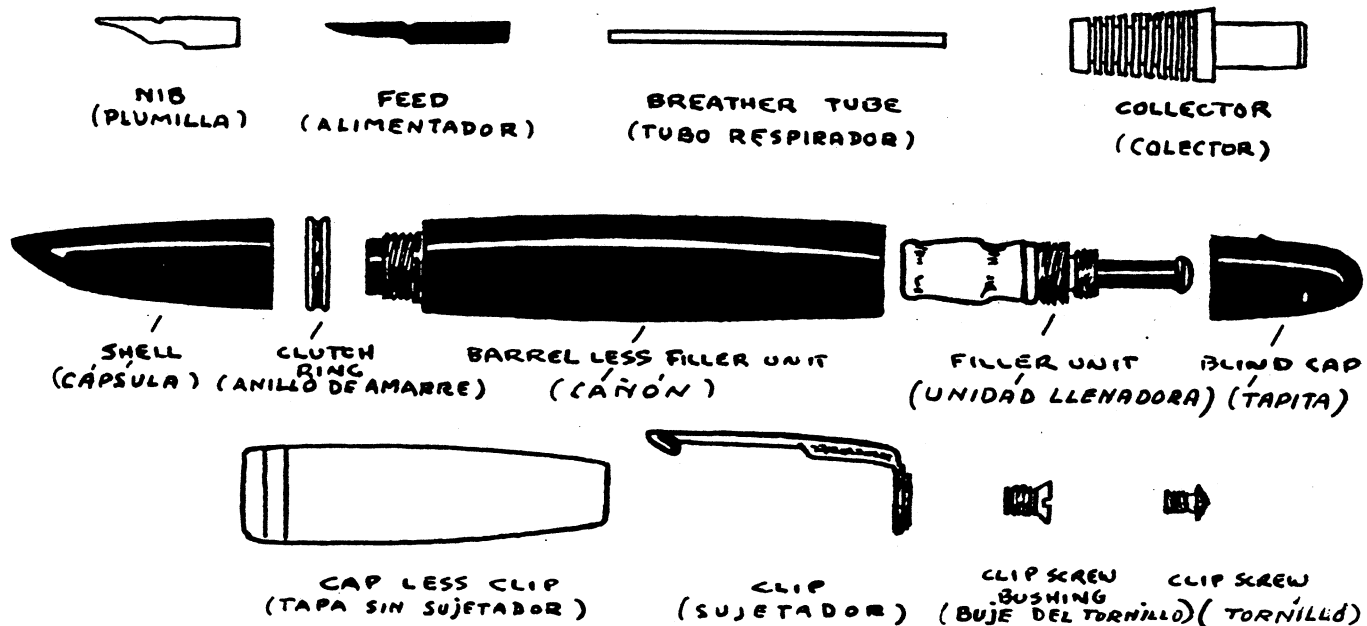

Fig. 39

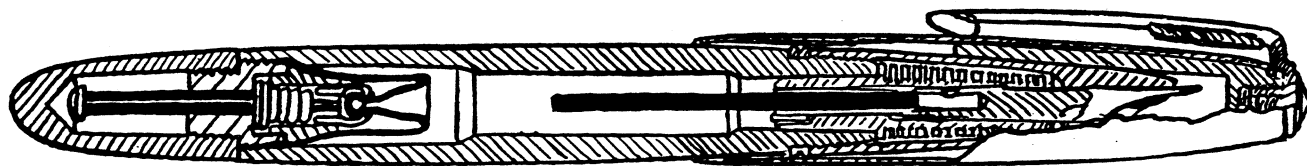

Fig. 40

To space and adjust the Parker Vacumatic nib, use the same methods as outlined for the sac button-fill pen.

THE PARKER "51" PEN (VAC-FIL)

This pen utilizes the same main principles of operation as the Vacumatic, but embodies a radically different form of construction.

The writing fluid is suspended within the barrel itself which acts as a reservoir, and is metered to the paper in a steady and consistent flow by means of various new devices. To more readily understand how the "51" differs from other pens, let us take a quick look at its distinctive features. Figures 39 and 40.

You will notice that the "51" has an entirely new and different part called the collector. The accompanying cross sectional diagrams of a collector, a collector and feed assembly, and a collector, feed and nib assembly will help to further explain the function of this part. Figure 41. The collector is so constructed that it seats into the front end of the barrel reservoir. A friction fit keeps it tightly in place. Notice that the exterior of the collector is deeply grooved by a series of cylindrically cut fins.

The interior of the collector is a center hole drilled in a series of steps. The inner diameter of the front of the collector is .144 inches. At the next step the inner diameter is .125 inches, and at the third step .112 inches. You will also notice that as the breather tube and feed bar assembly is inserted into the collector it seats firmly against the shoulder at the back of the .112 diameter hole. Because the next step increases the diameter of this opening to .125 and because the feed bar is actually .112 in diameter, an open space of .0065 inches surrounds the feed bar at this point.

The gold nib is inserted into the collector to the shoulder formed at the base of the .144-inch diameter hole. A space of approximately .0065 is created between the feed bar and the nib in this unusual assembly. This space which extends almost all the way to the tip of the feed fills with ink and acts as a reserve reservoir which may be called upon to make the pen write the instant the nib is touched to the paper. This space is known as the "annular space".

Some "51" feed bars were provided with a capillary channel which was cut into the top surface of the feed bar. It has been determined that "51" pens will perform better and with greater consistency with such a capillary cut. It should be made clear, however, that a "51" pen properly assembled will work well with a plain feed bar. Figures 42 and 43.

A saw cut on the under surface of the collector which extends practically from end to end opens into this annular space in the center of the collector. Thus, the writing fluid is metered from the ink reservoir through this saw cut, into the annular space, between the feed bar and nib to the slit in the nib and from there to the paper. Inserted into the saw cut at the back end is a small black plug or rod which looks like a heavy piece of horsehair. Figure 44. This plug maintains the accurate spacing in the saw cut when the collector is inserted into the barrel. It should never be removed from the collector or the saw cut would close and materially alter the amount of ink metered to the feed bar and the slit in the nib.

The cylindrically cut fins on the outer surface of the collector act as an overflow control for any surge of ink that might come from the ink reservoir. Such a surge of ink would flow into and through the saw cut and the ink would be absorbed by the capillary action of those fins. Thus, any tendency that the pen might have to leak is controlled.

As you write, ink flows out of the pen, air bubbles shoulder their way up through the saw cut and momentarily interrupt the flow of ink. Whenever this interruption takes place, the excess ink that is maintained in the last three or four fins of the collector flows to the nib in place of that ink which normally would be metered through the saw cut in the collector.

To sum up the performance of the governor, it (1) acts as an overflow reservoir to prevent leakage and (2) provides a steady and uninterrupted flow of ink to the nib.

The "51" pen is provided with a diaphragm and filler unit installed exactly the same as that in the extended filler Vacumatic.

There is one major difference in the filling methods of the Parker "51" and the Parker Vacumatic. The difference is that after the Parker "51" has been completely filled (usually after ten strokes of the plunger), the excess ink must be withdrawn from the fins of the collector. To accomplish this, the filling instructions of the Parker "51" say, "On the last stroke hold plunger down and then lift from the ink. When the pen point is out of the ink, release the plunger." This last operation clears excess ink from the collector.

When a Parker Vacumatic has been filled, the user generally wipes all excess ink from the half-moon cuts and side cuts of the feed with an absorbent piece of cloth. This operation clears the Vacumatic feed reservoirs so they may control any heavier than required ink surge. The "51" overflow reservoir cannot be cleared by wiping off the front end, for this reservoir is covered by the shell. Figure 45.

THE ABOVE FILLING INSTRUCTIONS ARE EXCEEDINGLY IMPORTANT AND SHOULD BE CAREFULLY EXPLAINED TO EVERY "51" USER.

The Parker "51" is equipped with a slip-fit cap. This fit is provided by means of a stainless steel clutch ring which is mounted between the shell and the barrel. A stainless steel clutch crimp rolled into the lower edge of the outer cap fits snugly over the clutch ring and anchors the cap firmly over the pen nib and front end of the barrel. A close examination of the cap will disclose the construction of the clutch. This clutch cannot be removed and any mechanical failure of the clutch necessitates an outer cap exchange.

DISASSEMBLY

Once again the same cleaning solutions and cold water rinses may be used on the "51" pen. Like the Vacumatic, the only parts that may be damaged by any of these cleaning solutions are the filler unit, the plunger and the spring. The blind cap must be screwed tightly on the barrel when cleaning the pen barrel.

Occasionally the "51" pen is dropped directly on the cap end causing the cap to become jammed onto the pen barrel. The Jammed Cap Remover No. 12029 makes the job of removing these caps a simple one. Instructions for using this tool are supplied with each tool--see Figure 46 for illustration.

The first regular step in disassembly is to remove the shell from the barrel of the pen. Grip the pen barrel with your rubber hand pad in the left hand and the shell with your rubber-covered section pliers in the right hand. Be sure the pliers grip the shell just ahead of the clutch ring, for if you were to squeeze down on the shell at about the midway mark, it would very likely break. The shell is supported by the barrel threads just ahead of the clutch ring and so considerable pressure can be exerted with your section pliers at this point. Next, with a quick snap of the wrist,

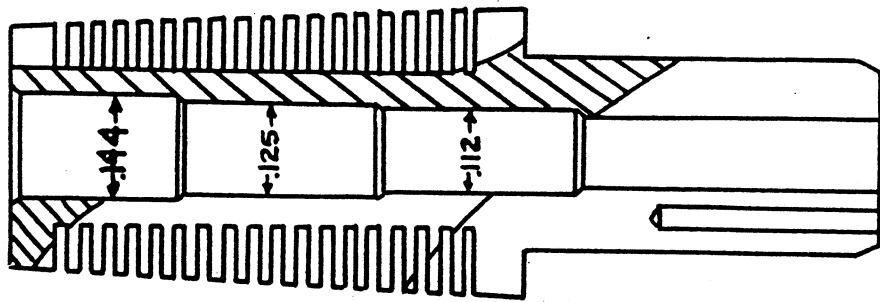

COLLECTOR
(COLECTOR)

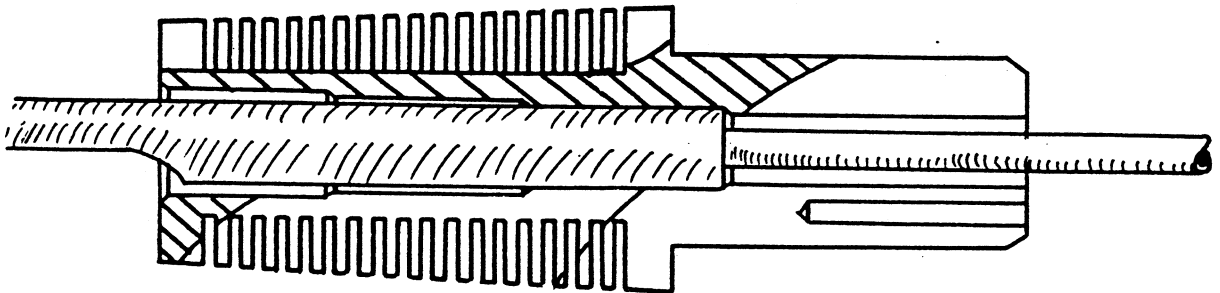

COLLECTOR WITH FEED BAR
AND BREATHER TUBE
(COLECTOR CON ALIMENTADOR Y TUBO RESPIRADOR)

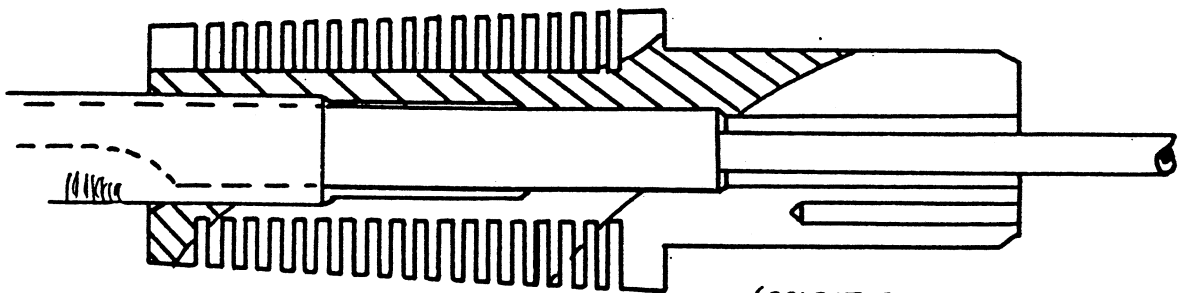

(COLECTOR CON ALIMENTADOR
TUBO RESPIRADOR Y PLUMILLA)
COLLECTOR WITH FEED BAR,
BREATHER TUBE AND GOLD NIB

Fig. 41



FEED WITH SLIT

Fig. 42



FEED WITHOUT SLIT

Fig. 43

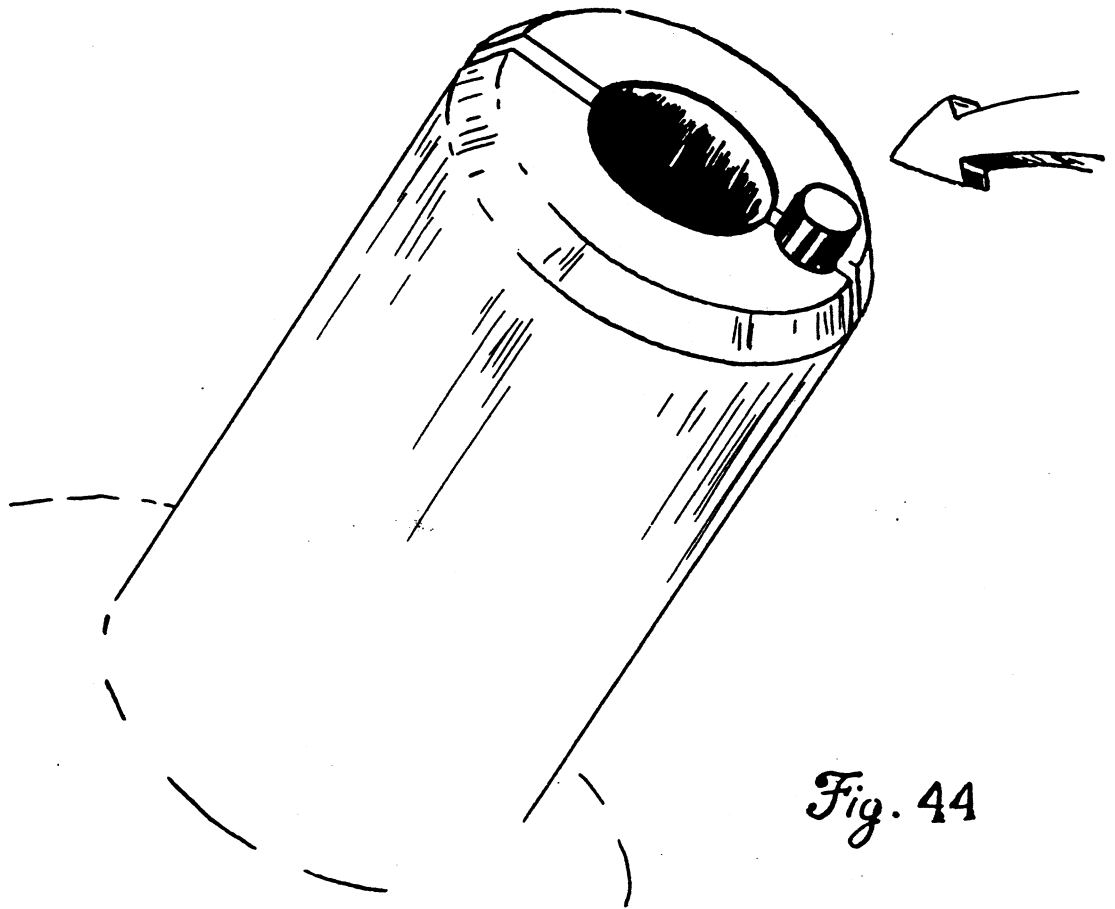

Fig. 44

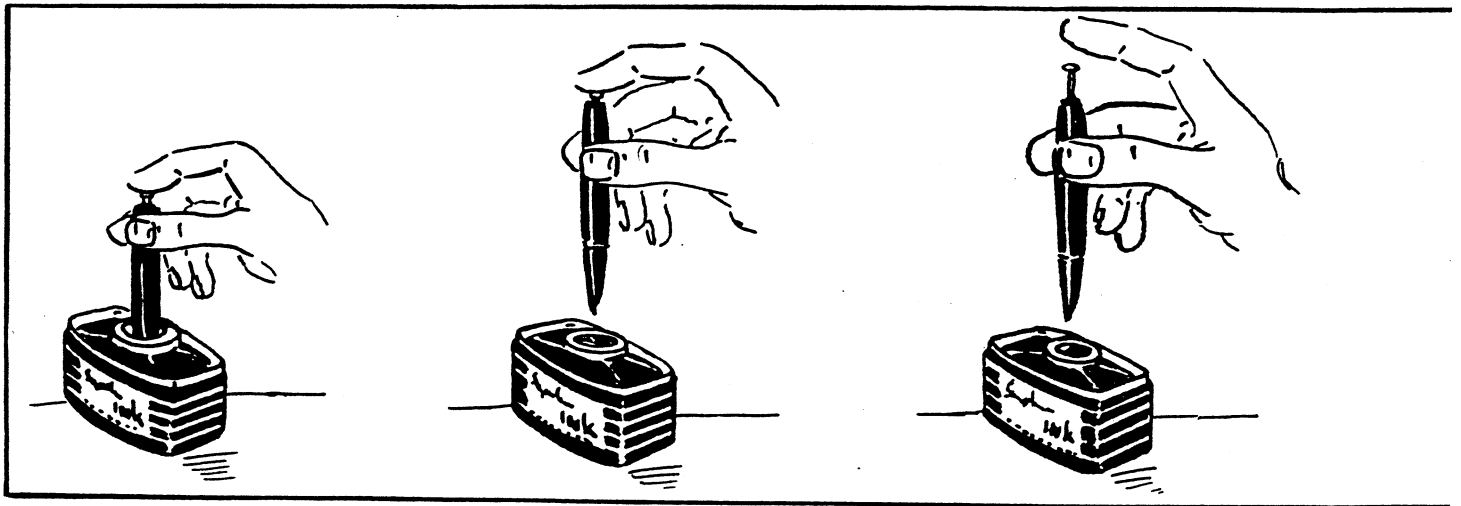

Fig. 45

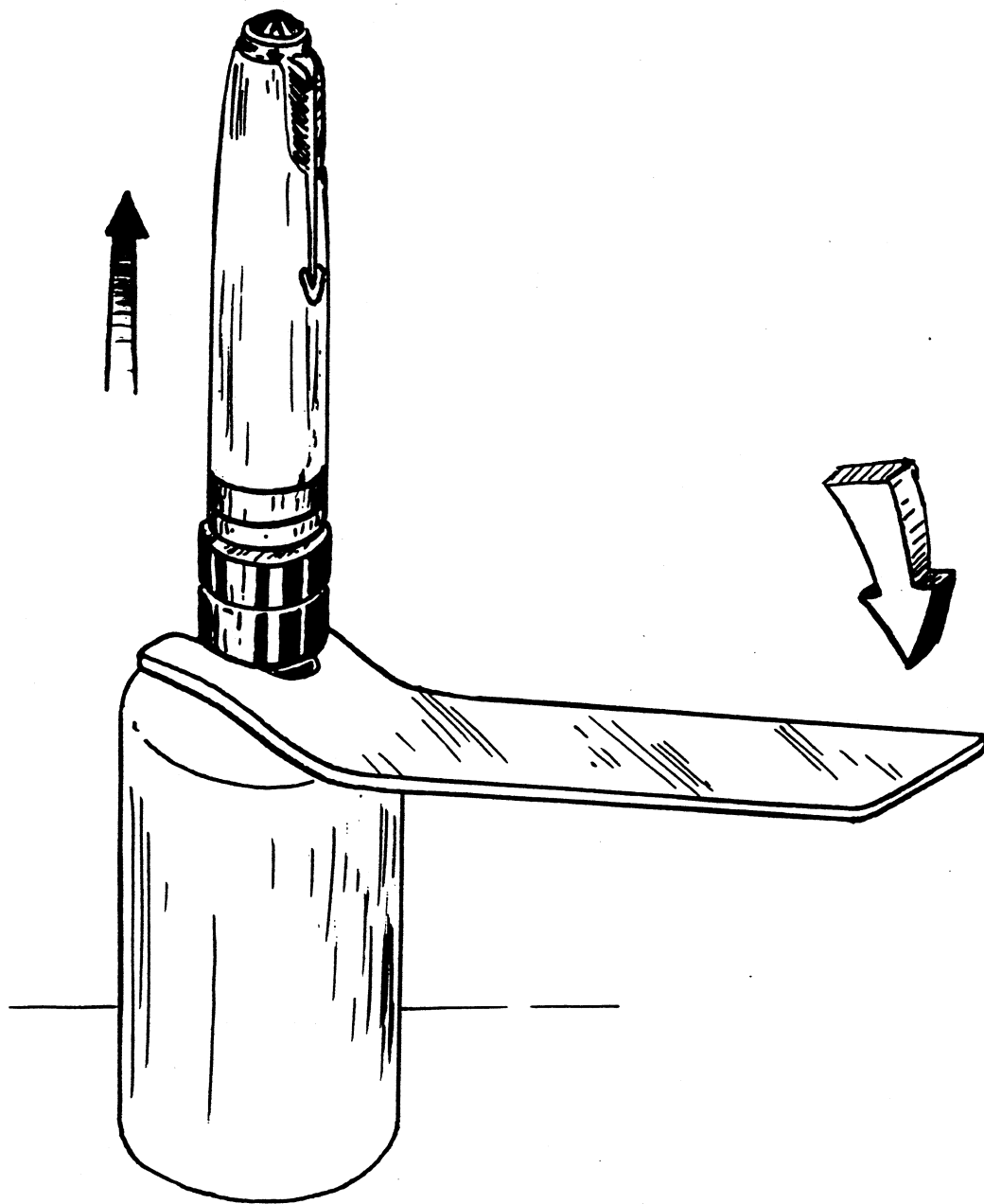

Fig. 46

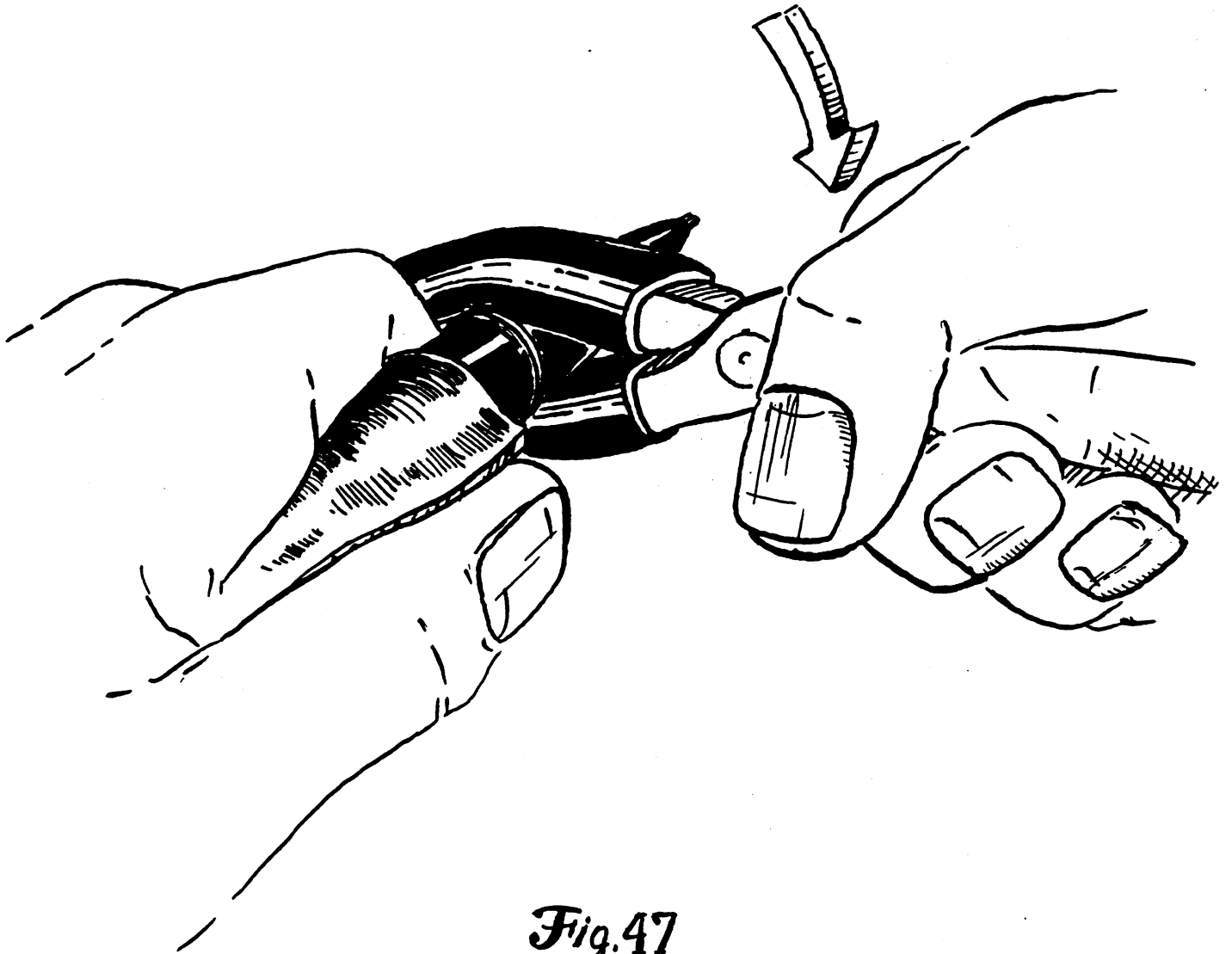

Fig. 47

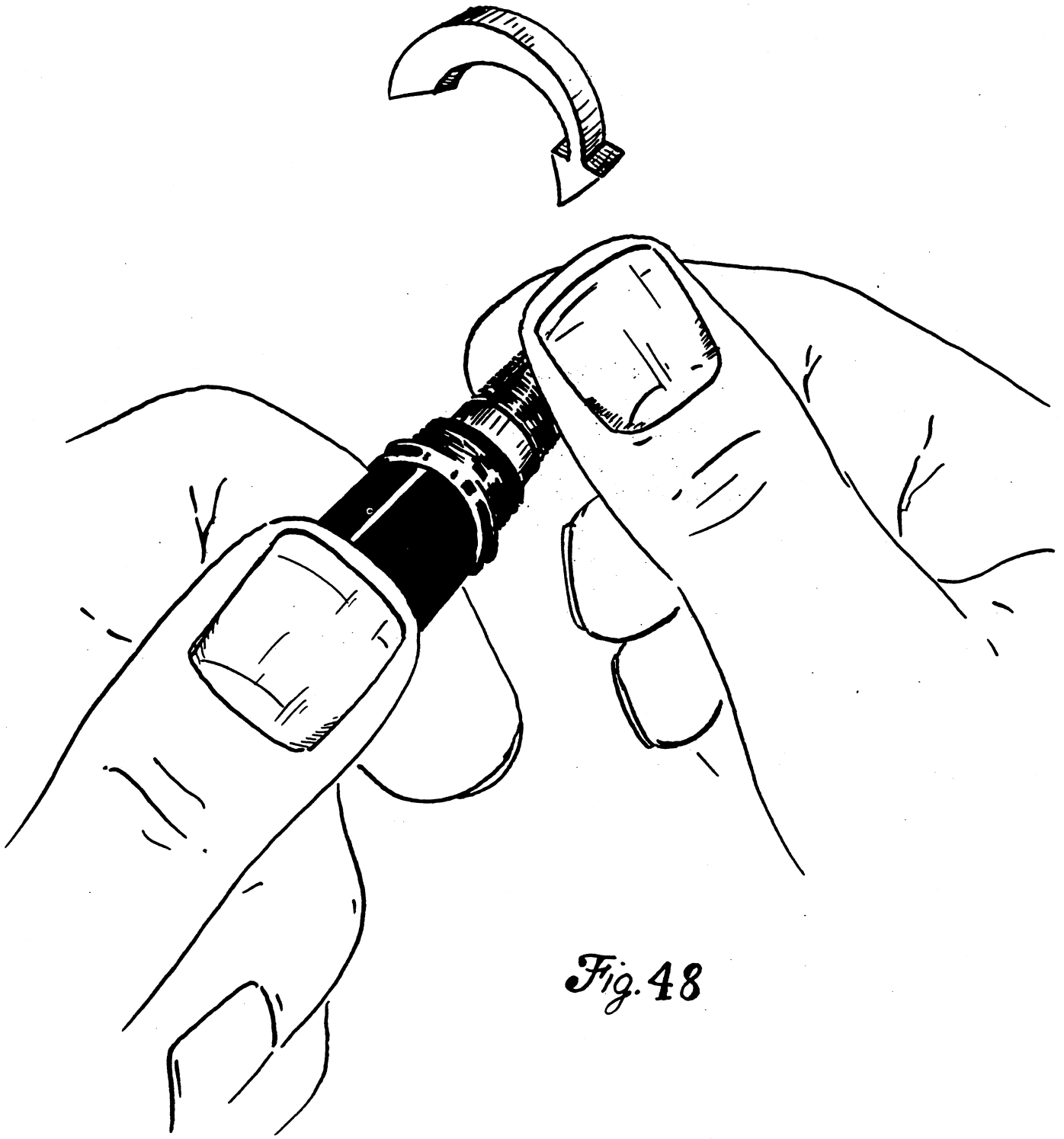

Fig. 48

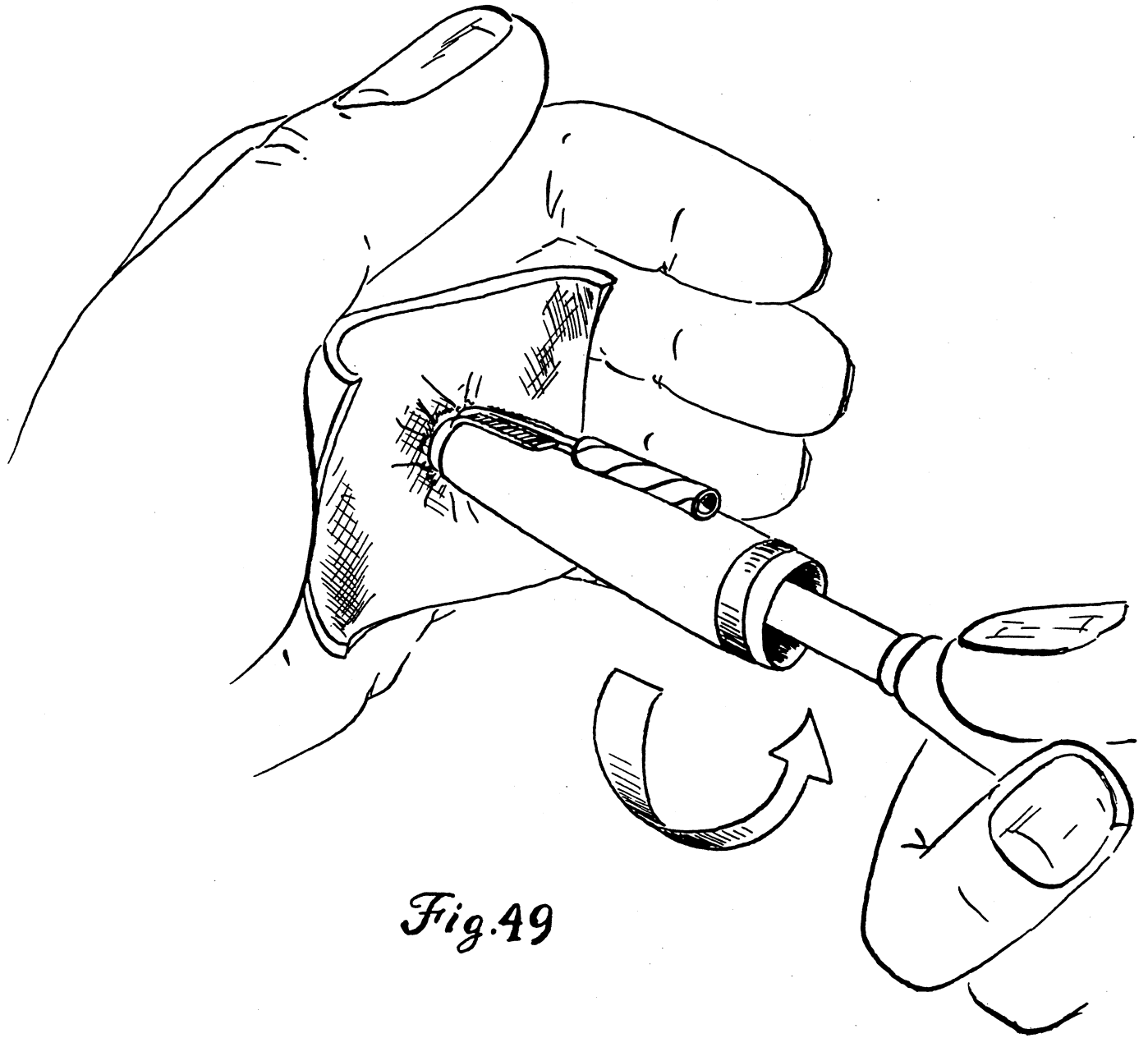

Fig.49

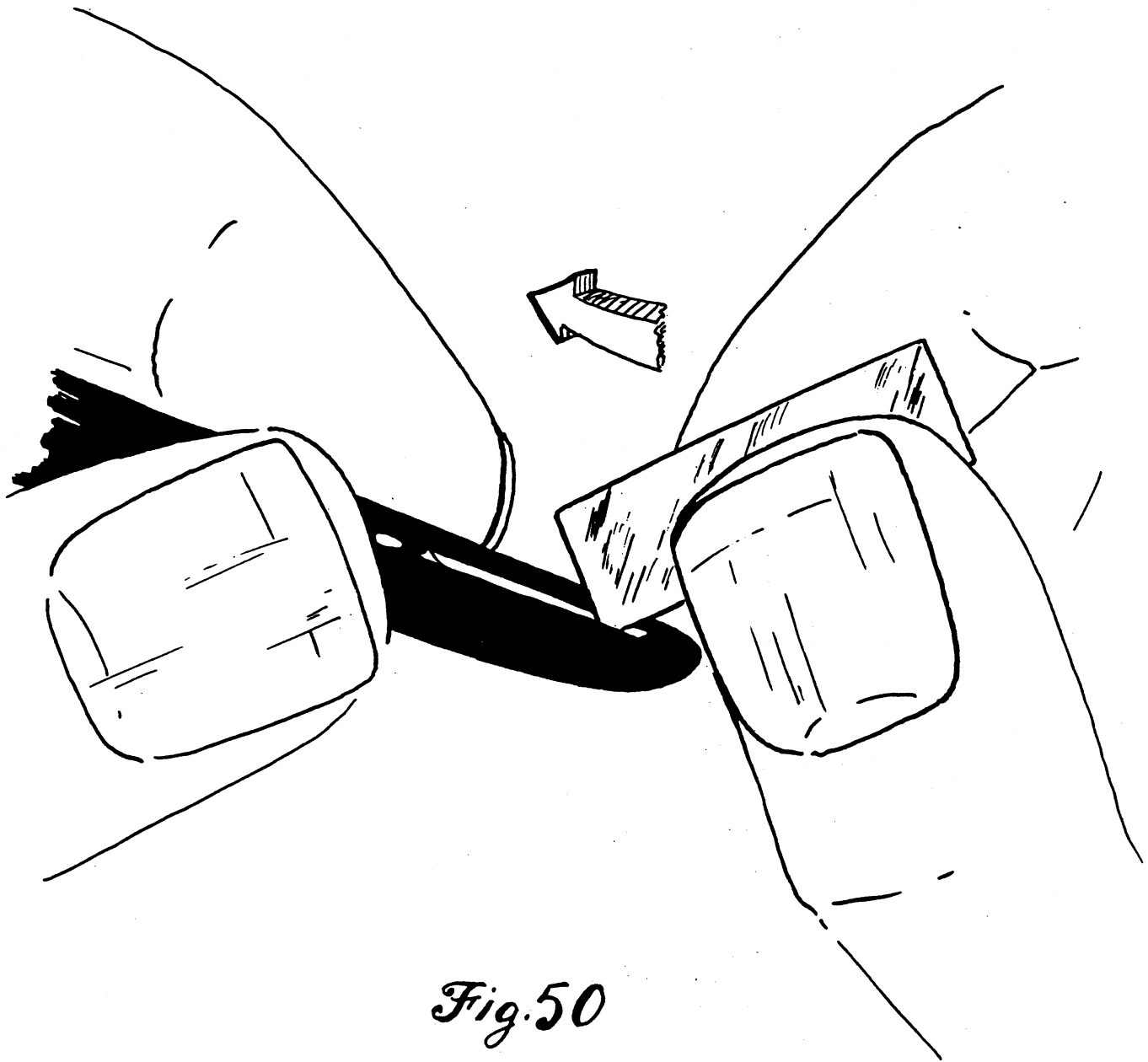

Fig. 50

twist the shell and unscrew it from the barrel in a counter clockwise direction. Figure 47. The clutch ring may then be removed by merely pulling it off of the barrel. The collector, nib and feed bar assembly may be removed from the barrel by grasping the fins of the collector between thumb and forefinger and twisting the collector loose from the barrel. The fit of the collector to the barrel is a friction fit and may be easily removed. Figure 48. CAUTION: DO NOT GRIP THE FINS OF THE COLLECTOR WITH THE RUBBER-COVERED SECTION PLIERS FOR THESE FINS BREAK QUITE EASILY!

The nib may be loosened from the collector by a simple twist and pull while grasping it between the forefinger and thumb of the right hand. The feed bar may also be removed from the collector in the same way.

The necessity for removing the filler unit should be determined by the same methods suggested in Vacumatic disassembly and the method of removal is exactly the same.

Should it be necessary to exchange the clip on the "51" pen, the use of the Inner Cap Arbor No. 8057 will simplify this job. Insert the inner cap arbor up through the outer cap and seat it firmly into the tapered inner cap. Ridges machined on the cap arbor provide a good "bite" or grip on the surface of the inner cap. To prevent the clip from marring the cap finish as it is removed, be sure to slip a piece of paper between the ball of the clip and the outer cap. Figure 49.

Next grasp the handle of the inner cap arbor with your right hand and hold the flat rubber in the palm of your left hand. Press the clip screw directly into the rubber pad in the palm of your left hand and give the inner cap arbor a sharp, counter clockwise turn. This will usually loosen the clip screw so that it may be easily removed. Figure 49.

The clip screw bushing may then be easily removed by using a screwdriver of the correct size or by using the clip screw wrench. This completes disassembly of the clip, clip screw and clip screw bushing from the pen cap.

Note: Occasionally a clip screw which refuses to budge will have to be cut out of the clip screw with a jack-knife or other sharp tool.

All of these parts with the exception of the filler unit, may be placed immediately in the cleaning bath. As in the case of the Vacumatic filler unit, the "51" filler unit should not be placed in the cleaning bath for this would have a tendency to corrode the spring. Always follow this cleaning bath with a cold water rinse.

ASSEMBLY

All of the parts of the Parker "51" pen must be carefully inspected to make sure that they are in perfect working order. If they are marred or show the result of hard usage but are still perfect functionally, they may or may not be replaced at the discretion of the repairman.

The nib should be given a very careful inspection to make sure that it is not clogged with ink sediment. The nib must not be marred or gouged, cracked or split. The ruthenium pellet on the tip should be inspected carefully to make sure that it is not chipped or broken.

The collector should be given a very careful inspection and a very thorough cleaning. Be sure that the small plug is in the saw cut of the collector and that it has not been removed.

If the feed bar is channeled with a capillary cut, be sure that this channel is opened with a small piece of slitting steel. Figure 50.

Make sure the breather tube and the airhole in the feed bar are open. If these holes are clogged, air cannot be ejected from the pen barrel and as a result, the "51" pen will not fill properly.

The feed bar must be curved slightly upward at the tip. Make a profile inspection. If the feed bar is flat, you may heat it carefully and mold it upward with your fingers. This slight upward curve maintains the annular space between feed bar and nib.

Inspect the barrel and the blind cap for cracks and exchange these parts if necessary. Check the outer cap carefully for any functional defect. If the lower edge of the outer cap has been damaged, it may mar the pen barrel when the cap is put on the pen.

Check for any pieces of rubber that may be stuck on the inner tapered shoulder of the "51" pen barrel whenever it has been necessary to remove the filler unit. These pieces may be removed as outlined for the Vacumatic filler units with a small amount of cigarette lighter fluid poured into the back end of the barrel. Be sure to rinse the barrel in cold water after using this fluid.

Inspect the shell of the "51" pen and make sure it is not warped or chipped at its very tip. Any chip discerned by the naked eye is large enough to affect the function of the pen. If such a chip or crack is obvious, it will be necessary to exchange the shell.

Any visible chip or crack on the tip of the feed bar will also affect the performance of that part.

If it has been necessary to remove the filler unit from the "51" pen, a new filler unit may be installed by following the method outlined for filler unit installation in a Vacumatic pen.

NIB ADJUSTMENT AND SPACING

Before any assembly procedure is started, it is necessary to space and adjust the "51" nib while it is outside of the pen.

The methods involved are very similar to those methods used in spacing and adjusting a Parker Duofold nib or a Parker Vacumatic nib. In order to increase the flow of ink, each prong of the nib should be bent slightly upwards. Conversely, in order to decrease the flow of ink to the paper, each prong of the nib should be bent slightly downwards. Bending each prong upwards increases the space between these prongs and bending the prongs downward decreases the space between these prongs.

To increase the space between prongs and thereby increase the flow of writing fluid to the paper, grasp the nib firmly between the thumb and forefinger of one hand and raise each prong a trifle with the thumbnail of your other hand. Figure 51. Some repairmen make use of the thin-nosed nib pliers for this operation.

When the nib pliers are used, they should be inserted parallel to the slit in the nib and back as far as the rear end of this slit. A gentle upward bend of the pliers will raise the prong a slight amount.

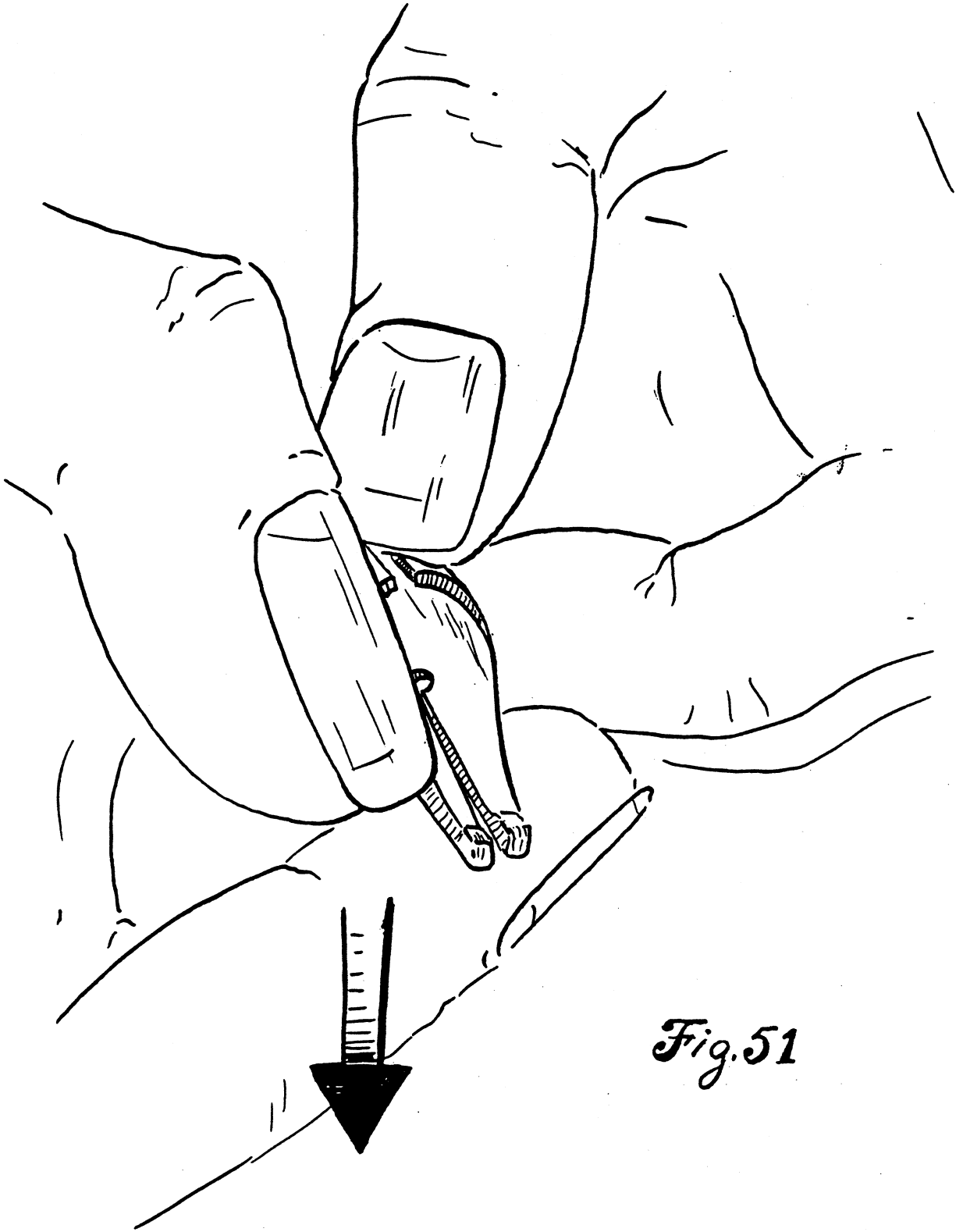
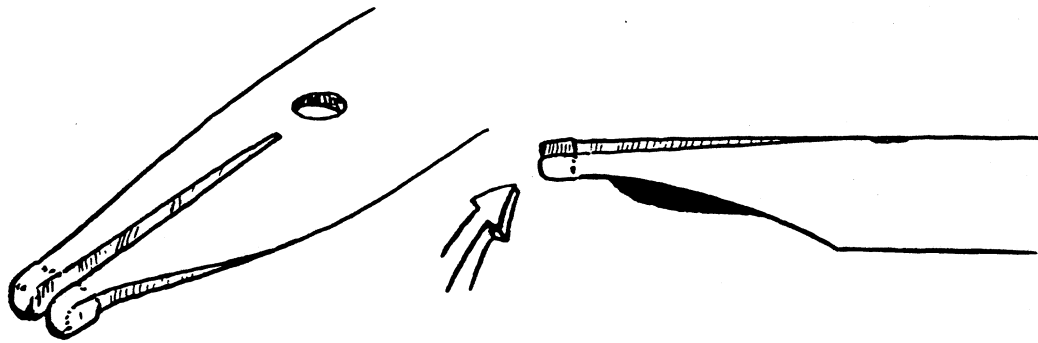
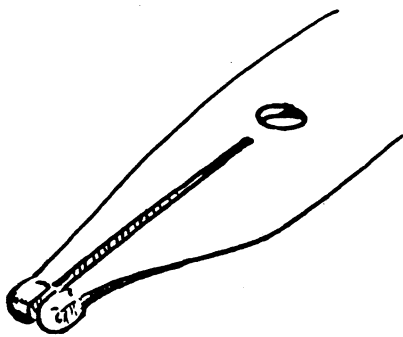

Fig. 51



SPRUNG NIB



CORRECT NIB

Fig. 52

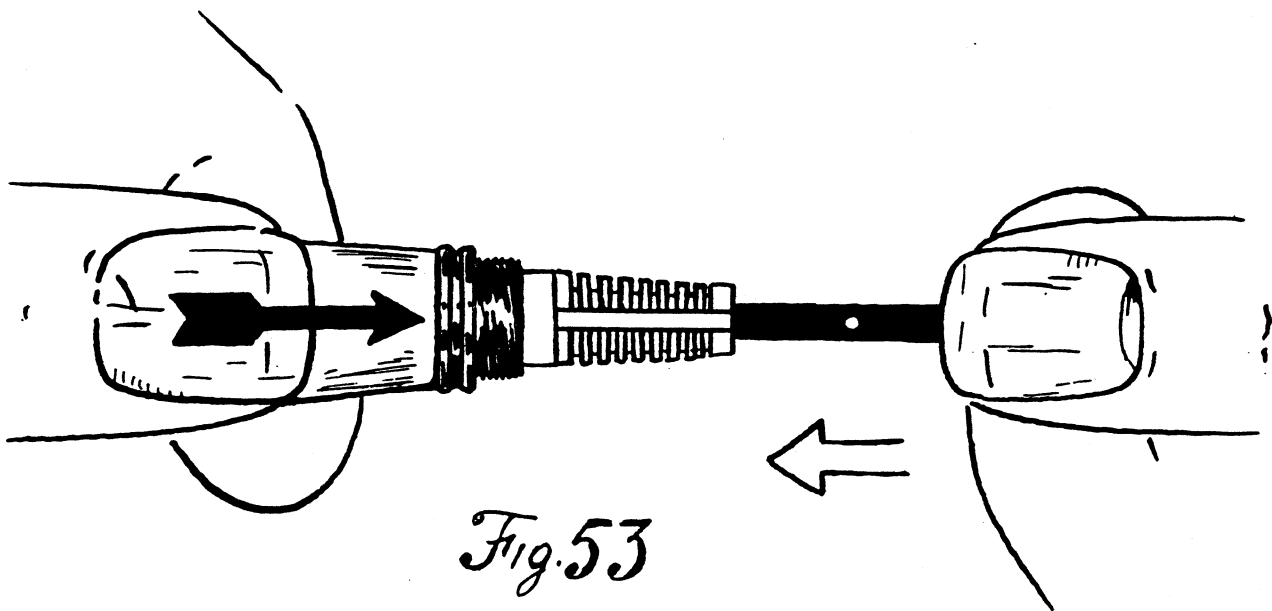

Fig. 53

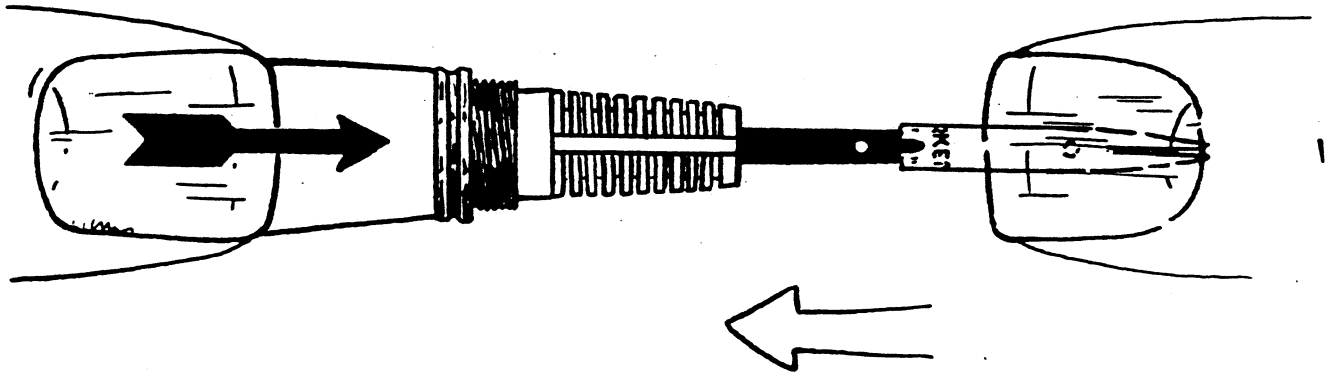

Fig. 54

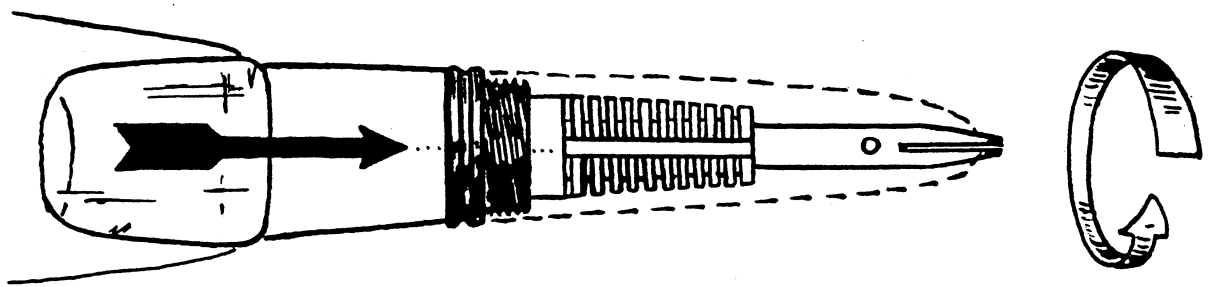
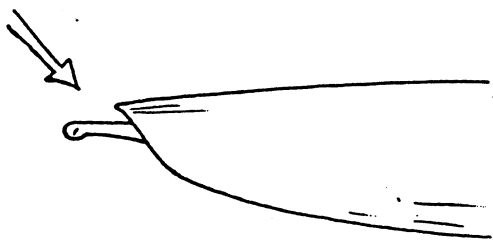
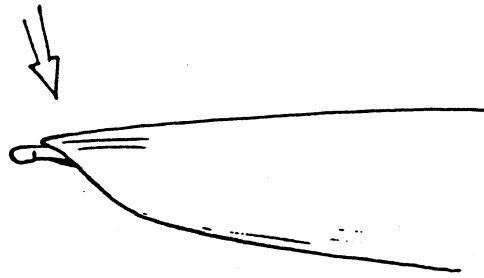

Fig. 55



WRONG



RIGHT

Fig. 56

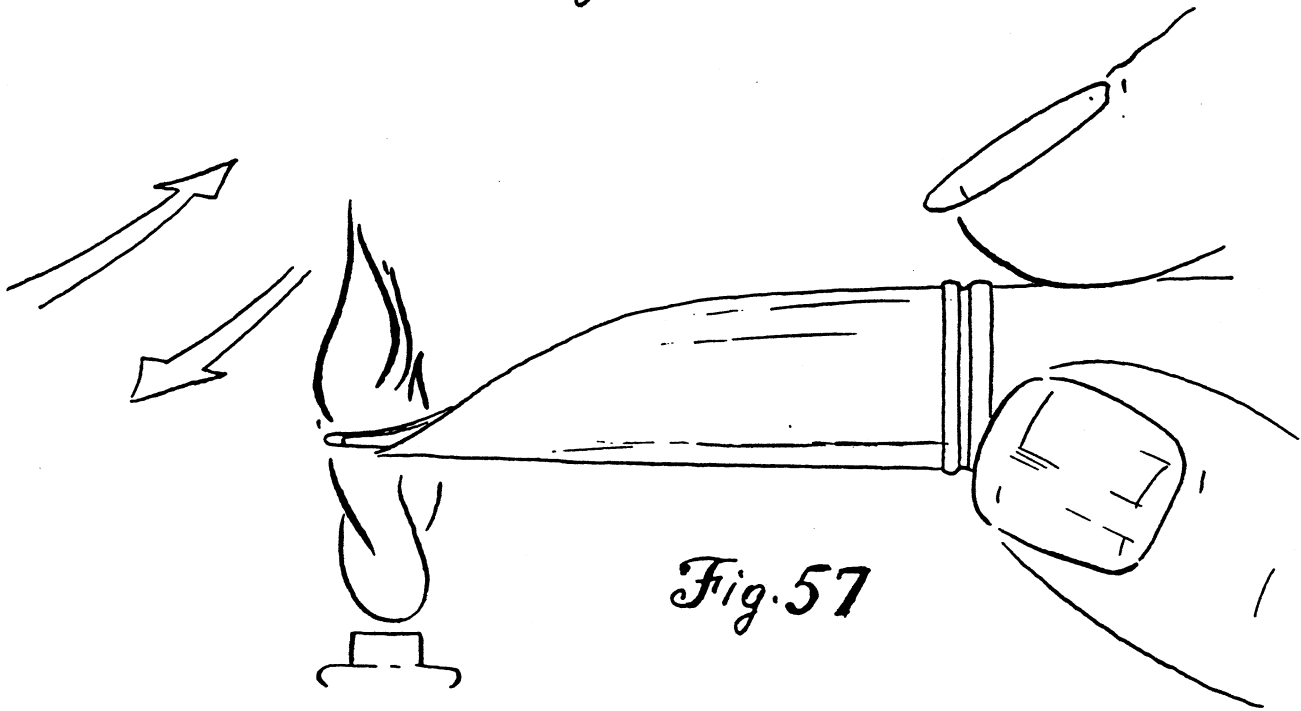

Fig. 57



Fig. 58

CAUTION: BECAUSE OF THE TUBULAR CONSTRUCTION OF THE "51" NIB, IT IS QUITE EASY TO CREATE THE TROUGHED NIB EFFECT IF THE PRONGS ARE BENT UP OR DOWN TOO FAR. A VERY DELICATE TOUCH IS NECESSARY FOR THIS OPERATION, PARTICULARLY IF NIB PLIERS ARE USED.

The thumbnail method is preferred by most repairmen and works very well for increasing and decreasing spacing and the resultant flow.

After the nib has been spaced, be sure you check to see that it is not sprung. Figure 52. Bending the high nib down or the low nib up will correct any sprung condition that occurs.

The first step after inspection of the parts and adjustment and spacing of the nib is the assembly of the nib, feed bar and collector. The breather tube of the feed bar should be inserted through the front end of the collector, and the feed bar should be grasped between thumb and forefinger and pushed firmly back into the collector. The back end of the feed bar will seat firmly against the shoulder machined on the inner circumference of the collector. Be sure the capillary cut (or the air hole in the top of the feed bar) is in line with the wide channel in the top of the collector. Figure 53. (If the feed bar and collector fit very tightly, it may be necessary to twist the feed bar slightly as it is installed).

CAUTION: The tip of the feed bar is very sharp. Be careful that you do not let it slip and pierce your thumb.

The next step is to insert the nib into the front end of the collector. To do this, grasp the nib and slip it over the tip of the feed bar and into the collector, seating it firmly against the inner shoulder of the collector by pressing the nib tip straight down on a hard surface such as the Fitting Gauge No. 9601. The pierce in the nib and slit in the nib must line up with the wide channel of the collector.

The collector, nib and feed assembly should now be installed into the barrel. To do this, insert the back end of the collector into the open end of the barrel pushing it all the way in.

The clutch ring should be slipped over the collector assembly into position on the barrel.

The next step is to screw the shell tightly onto the barrel. In most instances when this has been done, the tip of the shell does not fall into alignment with the slit in the nib. To obtain this alignment it will be necessary to rotate the collector assembly in the barrel until they do fall into line. In order to do this, most repairmen create an imaginary line down the center of their thumbnail and hold the pen barrel between thumb and forefinger just back of the clutch ring. This imaginary line should index the shell tip and should be in line with it. Gripping the pen barrel tightly so that this thumbnail index does not slip, the repairman should turn the shell tip off of the barrel and rotate or turn the collector assembly until the nib is in line with the imaginary center-line on the operator's thumbnail. (Be sure the collector is still seated firmly against the barrel.) The shell may now be screwed back into position and tightened until its tip just covered and bisects the slit in the nib. Figure 55. Just before the shell is tightened, apply a small amount of Shell Cement (specification No. 120) on the threads of the barrel in order to obtain a good seal between the shell and the barrel.

The shell tip should support the nib firmly from the top. If it is warped away from the nib slightly, it will allow the nib to wiggle back and forth and any amount of

play such as this may cause the pen to leak or give irregular flow characteristics. Figure 56. A piece of ordinary writing paper inserted between shell and nib should not slide under the shell tip more than 1/16 of an inch. If the shell tip is away from the nib farther than this, it should be molded down to the nib by means of a heat-down operation similar to that used to mold the Vacumatic feed up to the nib. Figure 57. After the shell tip has been softened by the application of heat, it may be pulled through the palm of the hand with a downward pressure. Figure 58. This will mold the shell tip down to the nib. CAUTION: Although the "51" pen is not very inflammable, it is possible to blister this shell tip quite easily.

You may find after this heat-down operation that you have molded this shell to the nib so tightly it presses the prongs down and together and shuts off the flow. When this happens, merely pass the nib and shell tip back and forth through the flame a few times and the nib will open up to its original spacing. This molding operation may also cause the nib to become sprung and reheating the shell tip will usually take care of the difficulty, allowing the nib to return to its original adjustment.

To decrease the flow, mold the shell tip down more tightly against the nib. To increase the flow, heat the shell tip and allow the nib to open to its original spacing.

When a major increase or decrease of the flow is necessary after the pen has been assembled, the repairman may use the "51" nib puller to remove the nib from the front end of the pen.

Insert the Nib Puller No. 8573R1 at an angle between the feed and the nib. Figure 59. Then straighten it up so that it is in line with the feed and nib and push it back until the small projection on the nib puller engages the pierce in the nib. When this happens, a "click" will be heard which indicates that the projection has dropped in place. Hold the pen in your left hand and the nib puller with your right forefinger and pull the nib straight out from the pen. Figure 60. Respace and readjust the nib as desired.

After the nib has been respaced and readjusted, it may be inserted through the front end of the pen, over the feed bar and into the collector. A straight downward push on a hard surface such as on the Fitting Gauge No. 9601 will seat the nib firmly on the collector.

If it has been necessary to remove the nib for readjustment after assembly, check to make sure that the shell lies tightly against the nib after the nib has been reinserted into the pen. If the shell needs to be remolded against the pen, be sure that this is done before you complete the repair job.

CAUTION: Pulling the nib from the assembled "51" pen will sometimes unseat the feed bar, and it will slide forward and project from the end of the shell. When this happens it will be necessary to disassemble and assemble the front end of the pen.

Examine the pen to make sure it functions correctly.

Aero-metric "51" Pen

The new Aero-metric "51" pen embodies several improvements in the filling system and ink flow control. Figure 61 shows the component parts of this pen.

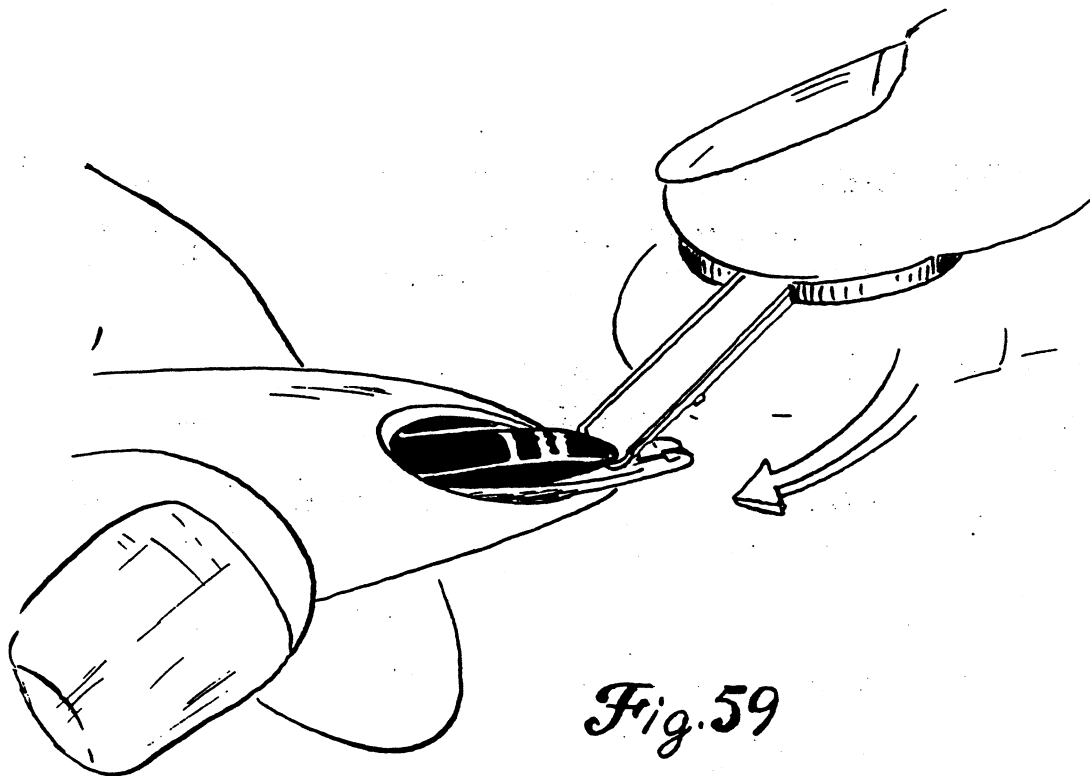

Fig. 59

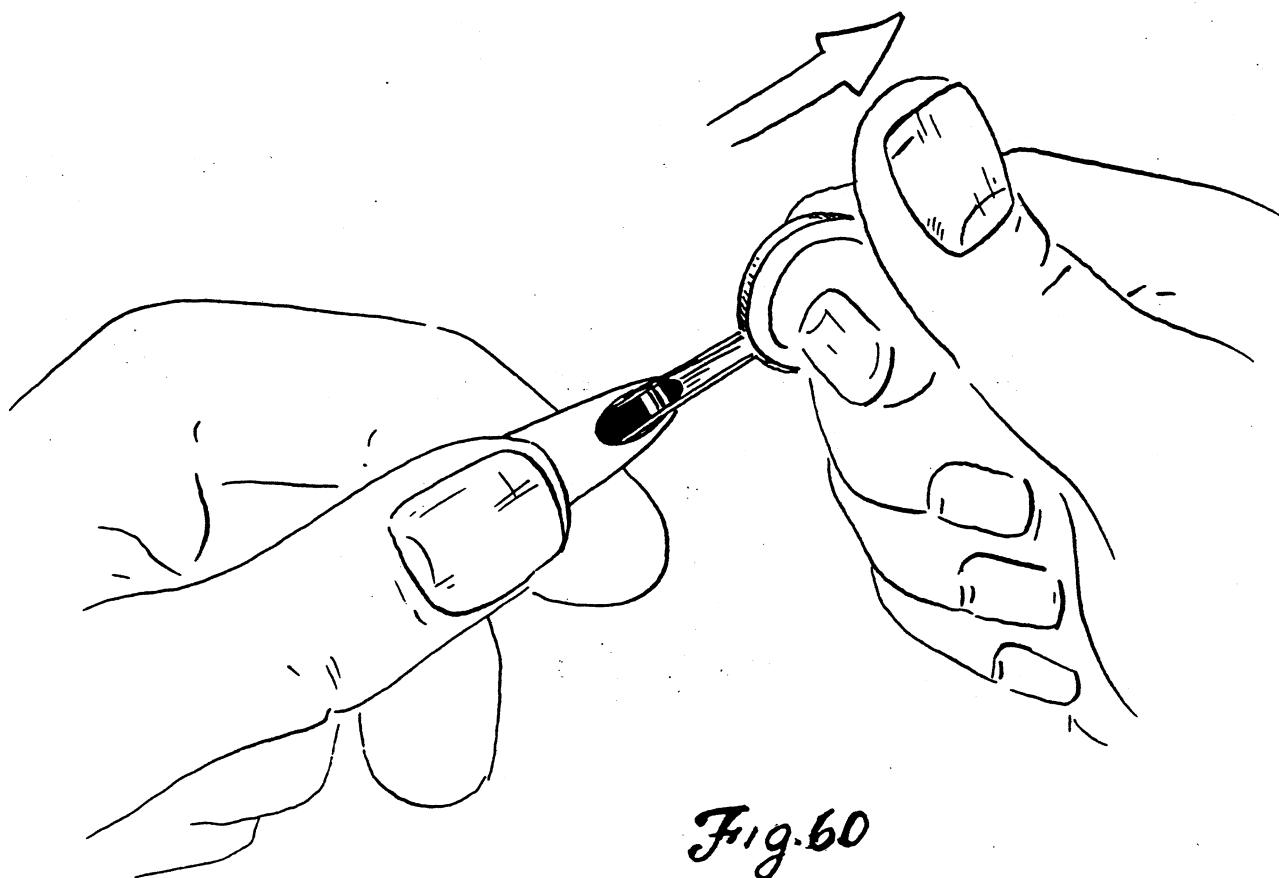
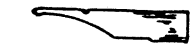
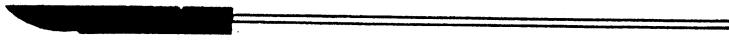

Fig. 60



NIB
(PLUMILLA)



FEED AND BREATHER TUBE
(ALIMENTADOR Y TUBO RESPIRADOR)

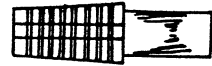

COLLECTOR
(COLECTOR)



SHELL
(CÁPSULA)



CLUTCH RING
(ANILLO DE AMARRE)

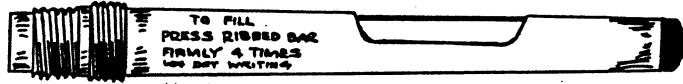

GUARD AND NIPPLE ASSY.
(CORAZA Y CONJUNTO ALIMENTADOR)

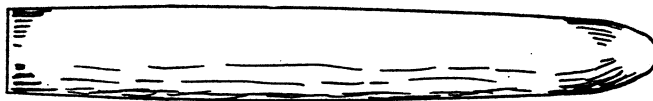

BARREL
(CAÑON)



CAP, LESS CLIP
(TAPA SIN SUJETADOR)



CLIP
(SUJETADOR)



CLIP SCREW BUSHING
(BUJE DEL TORNILLO)



CLIP SCREW
(TORNILLO)



PARKER AERO-METRIC "51" PEN
(PLUMA PARKER "51" AEROMETRIC)

Fig. 61

The most prominent change consists of an assembly which incorporates a front section, a sac or ink reservoir made of a newly developed translucent plastic known as Pli-Glass, a filler mechanism and a metal guard. These parts are supplied as a unit and cannot be disassembled.

The metal guard protects the sac and filler mechanism. A lateral opening of this guard allows access to the ribbed pressure bar of the filler mechanism and makes visible the ink supply.

DISASSEMBLY

Remove the barrel and insert the guard end of the pen in the Universal Nipple Wrench No. 12827 as you would into a barrel and grasp it tightly as with a filler unit wrench. Grip the shell just ahead of the clutch ring with the rubber covered section pliers and twist to remove it from the nipple. The amount of cement used under the shell in this pen has been increased and it may be necessary to heat the shell over an alcohol flame.

The clutch ring may then be removed. The collector, nib and feed bar may be removed as you would in the case of the Vac-fil "51". CAUTION: Ink usually remains inside the breather tube.

Following this, remove the remaining assembly from the wrench. Do not attempt further disassembly.

ASSEMBLY

Carefully inspect all parts to assure proper working conditions.

Give the collector a careful inspection and a very thorough cleaning. Be sure the small black collector pin is in place in the shank of the collector. Replace all collectors which have broken fins.

The feed bar is channeled with a capillary slot. Be certain this channel is open. The feed must be curved slightly upward at the tip. If found to be straight, heat it carefully over an alcohol flame and mold it upward with your fingers.

Check the silver breather tube for kinks, sharp bend, pinched areas and looseness in the feed. Replace if these conditions are found. Make sure the tube and its side orifice are not plugged.

Examine the guard for distortion and kinks.

Inserting the collector should not be a problem inasmuch as it is the same as the Vac-fil "51". Be sure the collector is fitted snugly into the nipple and that the "weir vent" testing procedure outlined on page 56 is followed.

The next step is to apply a generous amount of No. 120 cement to the nipple threads. Assemble the clutch ring to the nipple, using a twisting action to prevent piling the cement up behind the clutch ring. Using finger pressure tighten the shell down snugly against the clutch ring. The nipple wrench and the rubber palm grip may be used in this operation. We do not recommend the use of section pliers unless extreme caution is used as too much pressure against the clutch ring will force it back over the nipple threads. The Aero-metric shells require enough cement to seal and anchor them permanently in position. Therefore, the more cement used between the shell and nipple without waste, the better the shell will hold.

To complete the assembly, insert the feed and nib. (Some Aero-metric pens are supplied with an "O Ring" or rubber gasket which fits between the shell and clutch ring. Whenever a pen of this type is being repaired, we recommend that a new "O Ring" be installed.

Note: Identify the Demi feed by the shorter breather tube.

The feed can best be assembled into the pen through the use of the Aero-metric Feed Insertion Tool No. 12863R1. Insert the feed in the tool, press it firmly into its seat in the collector and remove the tool. The nib can then be partially inserted, aligned with the shell tip and pressed carefully into the collector by pressure against a pad of paper.

The procedure for spacing and adjusting the Aero-metric "51" nib is the same as that used on the Vac-fil "51" pen.

Cap and clip repairs are identical in technique to Vac-fil "51" pens.

Demi pens are serviced in the same manner as the Standard.

SPECIAL INFORMATION

The extremely close tolerances of all Parker parts allow all duplicate parts to be interchanged. However, because the collector of the "51" pen plays such an important part in governing the flow of ink from the reservoir to the nib, it is very important to test the collector weir vent in its assembled position. Certain conditions of assembly may result in an improperly spaced collector weir vent slot. When this condition exists, the pen may flood, skip or not flow at all.

COLLECTOR WEIR VENT GAUGING

This test applies to all "51" pens.

The collector weir vent feeler gauge is a special "Go - No Go" gauge to determine the mean free passage for ink flow through that channel of the "51" collector known as the weir vent. Figure 62. The "Go - No Go" gauge works on the principle that the "Go" (or minimum feeler) must enter the slot freely, and the "No Go" (or maximum feeler) must not enter the slot freely. This establishes the slot or weir vent within the limits that have been determined as the range for proper pen performance.

Those pens which allow the "No Go" feeler to enter the slot may have unstable ink flow control which can often lead to leaking, flooding or blotting. Those pens which will not allow the "Go" feeler to enter may show tendencies of skipping or starved flow.

The repairman should become thoroughly familiar with the technique of this test.

- Step 1. Assemble collector (with feed) up to within approximately 1/8" of the nipple. See Figure 63.
- Step 2. Without forcing try to insert the "No Go" (maximum) end of the gauge into the collector weir vent slot at the portion of the shank that remains exposed. Figure 64. If the "No Go" gauge fits snugly enough to allow lifting the pen off the work bench by the gauge, or if the

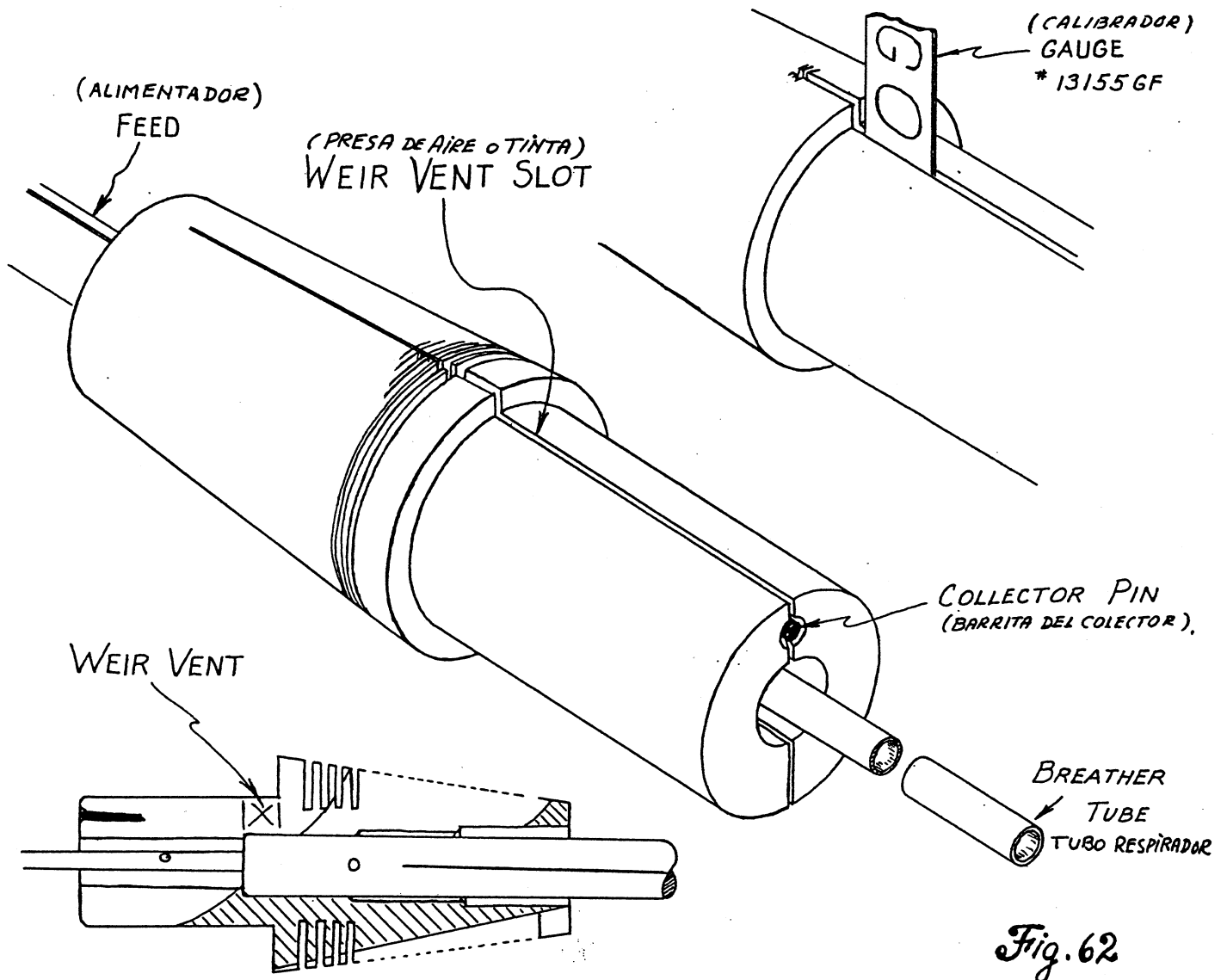

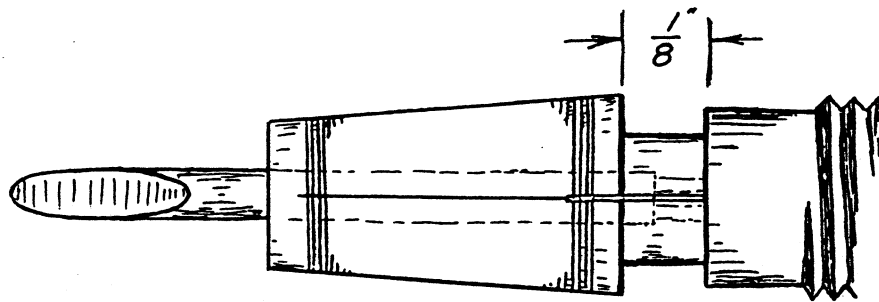

Fig. 63

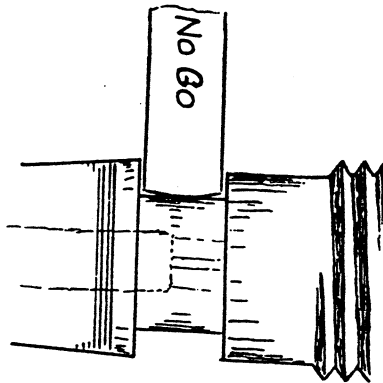

Fig. 64

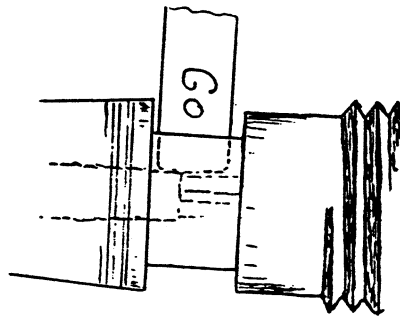

Fig. 65

slot will not accept the "No Go" gauge, the collector weir vent is within the maximum limit.

However, if the "No Go" gauge fits the slot loosely, the weir vent in this position is wider than the allowable maximum. Twist or rotate the collector approximately a quarter turn and repeat the "No Go" test. If not acceptable after testing in several positions, exchange the feed for another (preferably one which fits less snugly into the collector) and repeat the "No Go" test.

- Step 3. Having passed Step No. 2, insert "Go" end of the gauge into the collector weir vent slot. Figure 65. If the "Go" gauge fits the slot loosely, or with only a slight amount of drag (not enough to allow lifting the pen suspended from the gauge) the collector weir vent is within the minimum limit.

However, if the "Go" gauge fits the slot snugly enough to allow lifting the pen, or if the slot will not accept the "Go" gauge, the weir vent in this position is below the allowable minimum. Twist or rotate the collector and repeat the "Go" test. If not acceptable after testing in several positions, exchange the feed for one which fits more snugly into the collector and repeat the "No Go" and "Go" tests.

- Step 4. If a collector is removed for failing Step No. 2 or Step No. 3, it is best to replace with a collector removed for the other reason.

CAUTION: ONCE A COLLECTOR HAS BEEN SUCCESSFULLY ASSEMBLED INTO A BARREL OR NIPPLE, IT MUST NOT BE TURNED OR ROTATED SINCE THIS MAY CAUSE THE WEIR VENT TO OPEN OR CLOSE SLIGHTLY.

CONTINUOUS FEED PENCIL

To disassemble the Continuous Feed pencil, the cap and eraser are first removed and the magazine emptied. Extend the mechanism and push all the lead out of the point clutch using Knock Out Wire No. 13173. In severely jammed pencils the small drill No. 13174 may have to be used to remove crushed lead.

Having removed all the lead, loosen the round bushing at the end of the barrel by using the rubber pad so that the movement can easily be withdrawn. The clutch assembly should be removed next. Using the tip of the nib pliers, loosen the two flat arms of the assembly lock that are wrapped completely around the lower part of the eraser cup holder assembly. The assembly lock can now be slid toward the eraser cup to the limit of its travel. Move the copper colored actuating clutch forward. Figure 66.

Remove the two clutches by squeezing tightly at the back end and pulling sharply outward. Unscrew the point from the barrel using the rubber palm grip.

The Continuous Feed pencil parts must be inspected. Examine the point clutch for flared clutch jaws and for insufficient lead drag. Insert a piece of lead in the jaws. There should be enough drag exerted on the lead to prevent the lead from being easily shaken off the point. In some cases flared jaws may be corrected by squeezing the jaws together between the fingers or with the careful use of nib pliers. Look also for spots where the base metal shows through the heavy chrome plate. If any are found, exchange this part.

Check the berrilium copper actuating clutch for burrs and bent or unaligned clutch jaws. The actuating clutch should be replaced if there is a complaint of continued jamming.

Next assemble the two clutches and test the drag between them by moving the actuator clutch with your fingers. Experience and experimentation will soon teach the repairman to detect the proper amount of drag between the clutches. If the actuating clutch is too loose, the pencil may not expel lead. If it is too tight, the pencil may break lead, jam with lead shavings, etc. A simple set of rules to go by is as follows:

1. If the actuating clutch can be moved along the point clutch with light single finger pressure, the drag is probably insufficient.
2. If the drag is heavy enough to require two fingers exerting light squeezing pressure on the clutch to move it, the drag can be considered as being suitable for further assembly.
3. Whenever much effort is required to move the actuating clutch, the assembled clutches have excessive drag.

If the drag is either insufficient or excessive, interchange parts until a passable combination is found. It is often possible to obtain a suitable assembly by placing the actuating clutch on the other half of the point clutch. CAUTION: Do not attempt to adjust the tension of the actuating clutch--try different actuating and/or point clutches. Save all undamaged clutches for many can be used.

When the proper drag has been obtained, slide the actuating clutch forward as far as possible. Having first made sure the assembly lock is in position, assemble the clutches to the eraser cup holder assembly by squeezing the rear halves of the point clutch together and forcing them into the proper opening of the lead guide, using a direct push or a rocking action. Line up the halves of the point clutch with the assembly lock lugs and slide the lock into position.

Secure the assembly lock by squeezing the arms into the groove provided. Use a pair of old nib pliers with the tips bent in slightly enough to fit the curvature of the assembly lock. The lock must be tight with no movement or play.

To continue assembly, inspect the point replacing it with a new one if burrs, gouges, dents or marred plating are present. Then screw the point into the barrel and use the rubber palm grip to tighten it.

Next, place the spring over the movement, insert the movement into the barrel, force the movement down into the barrel and screw the assembly bushing into the barrel. Use the rubber grip to secure the threads tightly.

The mechanism is now assembled ready for testing. Extend the mechanism and insert one piece of lead into the point clutch jaws. Place several leads into the eraser cup holder (not more than 10 or 12).

Check the operation by pumping the mechanism 44 times. During this test, at least one full lead, but not more than two, should be expelled. Expose the lead by pumping the mechanism several times and then break off the lead. A single movement of the mechanism should project enough lead to allow the use of the pencil for writing. Check the holding power of the clutch by pushing directly down on the pencil with the lead against a hard surface.

To replace an outer cap, remove the clip and push out the cap clutch with a screw

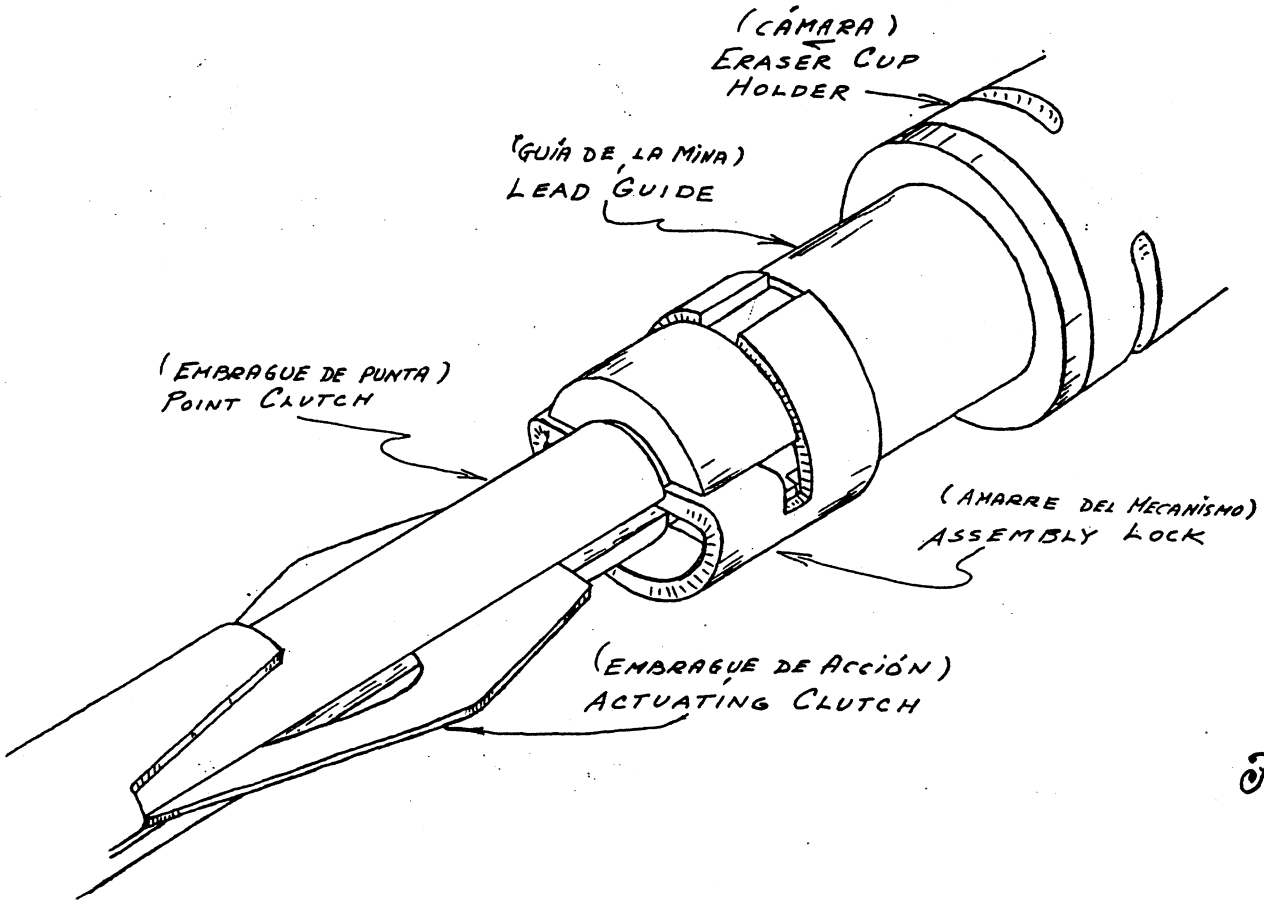
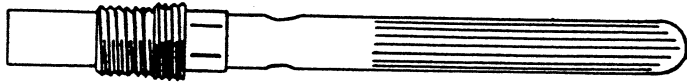
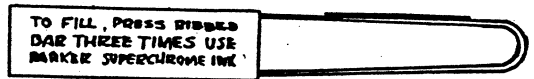

Fig. 66



NIPPLE and RESERVOIR ASSEMBLY
(CONJUNTO DE SECCIÓN Y LLENADOR)



GUARD ASSEMBLY
(CONJUNTO DE CORAZA)



OCTANIUM NIB
(PLUMILLA)

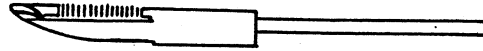

FEED ASSEMBLY
(CONJUNTO ALIMENTADOR)

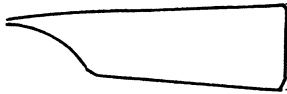

SHELL
(CAPSULA)



CLUTCH
(ANILLO DE TENSION)



CLUTCH RINGS-(2)
(ANILLOS DE AMARRE - (2))

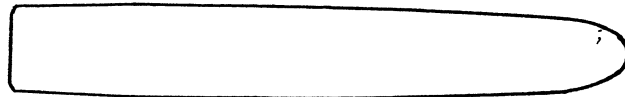

BARREL
(CAÑON)



CLIP SCREW
(TORNILLO)

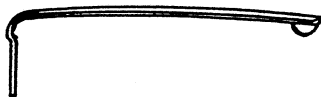

CLIP
(SUJETADOR)

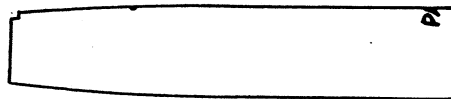

OUTER CAP
(TAPA EXTERNA)



INNER CAP
(TAPA INTERIOR)

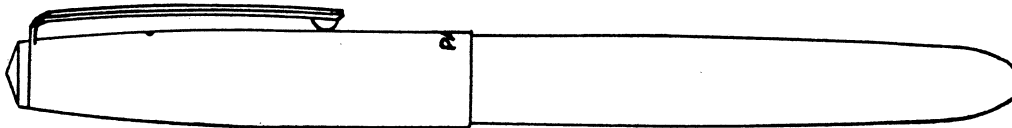

PARKER "21" PEN
(PLUMA PARKER "21")

Fig. 67

driver or some other slender tool. Insert the cap clutch in a new outer cap and attach the clip. In case a cap is causing trouble because it fits too loosely on the mechanism, remove the cap clutch and bend it into a slightly more oval shape. This increases the drag between the cap clutch and the mechanism without causing any visible marking or distortion of the mechanism.

THE PARKER "21" PEN

(Figure 67)

The Parker "21" is a truly modern pen in every way. The nib is entirely new, the filling up-to-date and the design functional and stylish.

Point: The nib of the "21" is made of a new metal called Octanium. This metal point is tipped with an Osmiridium pellet to provide smooth writing and maximum durability.

Feed: The "21" feed is machined from solid lucite. The special flow compensator meters ink to the point and prevents flooding. The breather tube (made of semi-flexible Saran) is drilled at the side to provide overflow control in the point up position.

Shell and Clutch Ring: A plastic shell protects the feed and nib and eliminates the possibility of the ink drying out. The clutch ring of the "21" pen is so designed that a clutch in the cap is not needed. A metal ring assembled as part of the clutch ring and shaped somewhat like a clover leaf provides clutch action when the cap is pressed over it.

Guard and Filler Mechanism: The guard protects the reservoir from careless handling and supports it during violent motion of the pen. Filling instructions are engraved on the stainless steel guard. The pressure bar is securely welded to the guard in the proper operating position. The translucent pli-glass reservoir is visible for over half its length, allowing full view of the ink supply in the pen.

General: The nib and feed are assembled as a unit by press-fitting them into the front of the nipple. Both clutch ring and shell are located on the forward portion of the nipple while the guard and reservoir are attached at the rear of the nipple. The reservoir is permanently secured to the nipple by a special bonding process. A completely removable barrel discloses the "21" filler mechanism.

Cap: The cap consists of an outer metal cap, a clip and an inner cap. The clip is secured to the cap by a large clip screw. This cap is not interchangeable with the "51" model cap.

Filling: Figure 68. To fill the "21" pen, remove the barrel, immerse the point in ink to a depth great enough to cover the shell opening and press the ribbed bar slowly three times. After filling, the user should hold a wiping tissue against the point and feed for several seconds to remove excess ink from the feed.

SERVICE INSTRUCTIONS

The following tools are essential in the repair operations on "21" pens and pencils:

"21" Assembly Tool No. 13373

"21" Pencil Clip Tool No. 13346

Installation of Assembly Tool No. 13373 should be made on the front edge of the bench beside the operator. Figure 69.

DISASSEMBLY

To disassemble the "21" pen, remove the barrel. Remove ink from the pen by whirl cleaning or by squeezing the pressure bar several times.

Grasp the nipple threads with the universal nipple wrench as you would an Aero-metric pen. Grip the shell with the rubber covered section pliers and twist to remove it.

Grasp the nib and feed with the rubber protected jaws of the Bernard pliers. Twist and pull apart. Be sure to use only a minimum amount of pressure to prevent the fins of the compensator from breaking.

Note: Never apply any type of flame directly to the plastic.

Reverse the position of the pen in the universal nipple wrench end for end. Grasp the guard firmly with a rubber palm grip and twist to remove. The guard is press-fitted to the nipple; therefore, considerable force must be exerted. Do not remove guard unless it or the nipple and reservoir assembly is to be replaced.

Removal of the clutch and clutch ring presents no problem since they are not fixed or anchored. In removing the clutch ring, an application of lighter fluid to the threaded portion of the nipple will soften the cement and allow the clutch ring to be taken off with ease. Note: It is essential for proper assembly that the repairman observe whether it was assembled tightly against the barrel threads.

To disassemble the pen cap use the rubber palm grip and the inner cap arbor No. 8057 in the manner used to remove "51" clip screws, unthread the "21" clip screw. In some cases careful use of the rubber covered section pliers may be needed. Stubborn cases can be handled by applying heat from the alcohol flame directly to the clip screw.

When the clip screw is removed, the inner cap can be easily disassembled. Tip up the clip and rotate it enough so that the head can be withdrawn from inside the cap.

ASSEMBLY

Examine all of the parts of the pen. Clean and inspect the feed to be certain the flow channels are not clogged. Figure 70. Be sure all flow compensator fins are intact. Replace the feed in case of broken fins. The breather tube and cross hole should not be obstructed.

Examine the guard and pressure bar for unsightly scars, marks or improper contour. Slight adjustments to the pressure bar can be made with the fingers or nib pliers. Replace all parts that are faulty.

To completely assemble the "21" pen, place the guard assembly (pressure bar down) into the center hole of the "knock out block". Insert nipple assembly into the guard and force the nipple into the guard. Figure 71.

Place the guard and nipple assembly into the Universal Nipple Wrench and install the three piece clutch ring using two clutch rings and one clutch. Apply a generous amount of No. 120 cement to the nipple threads and install the shell. To complete the repair, assemble nib and feed. Using Fixture No. 13373 in the manner outlined

"21" PEN

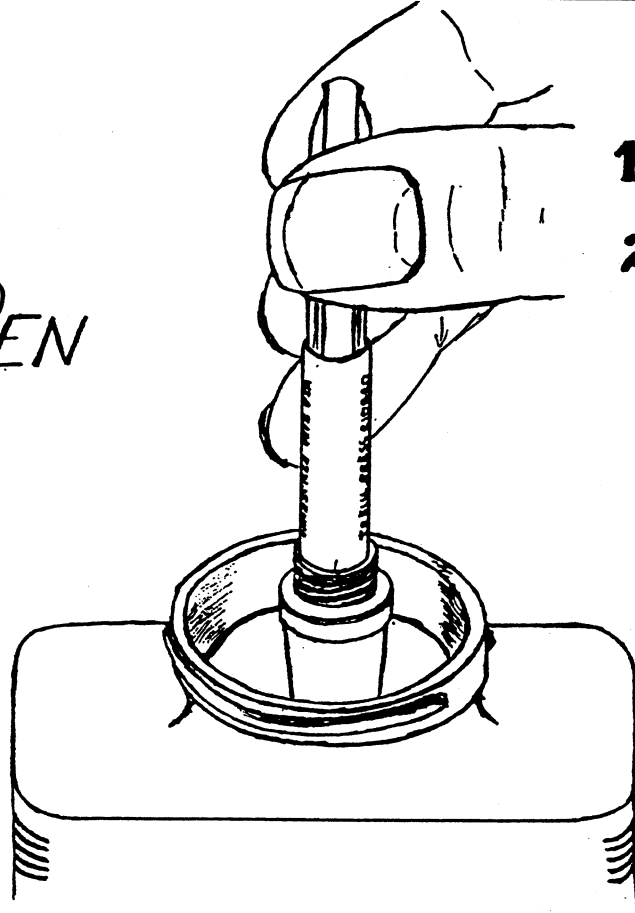

- TO FILL: (PARA LLENAR:)
1. REMOVE PEN BARREL.
(DESATORNILLE EL CAÑÓN)
 2. IMMERSE POINT IN INK;
PRESS RIBBED BAR 3 TIMES.
(SUMERJA LA PLUMILLA; DEPRIMA
LA BARRA 3 VECES.)

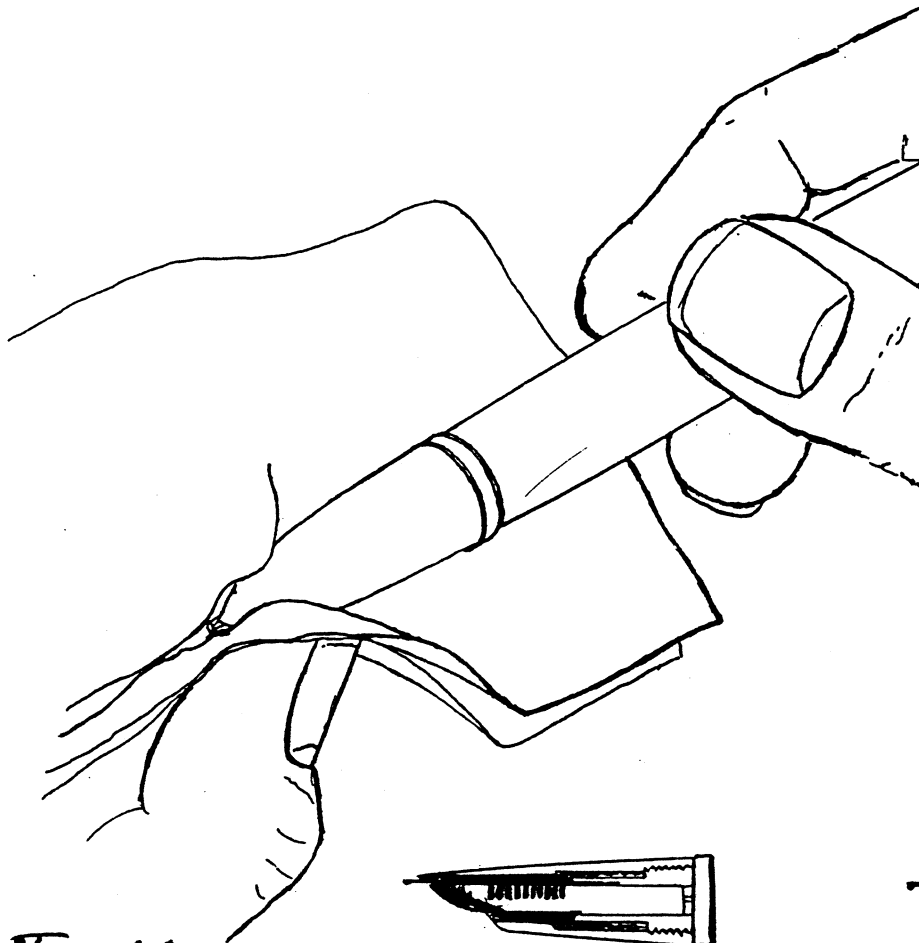

AFTER FILLING - REMOVE
EXCESS INK BY HOLDING
TISSUE TO POINT AND
FEED FOR SEVERAL
SECONDS.

(DESPUES DE LLENADA:
LIMPIE EL EXCESO DE
TINTA DE LA PUNTA Y
EL ALIMENTADOR CON
UN TEJIDO O PAPEL
ABSORBENTE MANTENIENDO
EN CONTACTO POR VARIOS
SEGUNDOS -)

Fig. 68



BEFORE WIPING
ANTES DE LIMPIAR

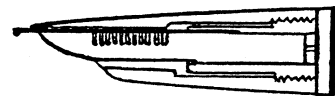

AFTER WIPING
LIMPIADA

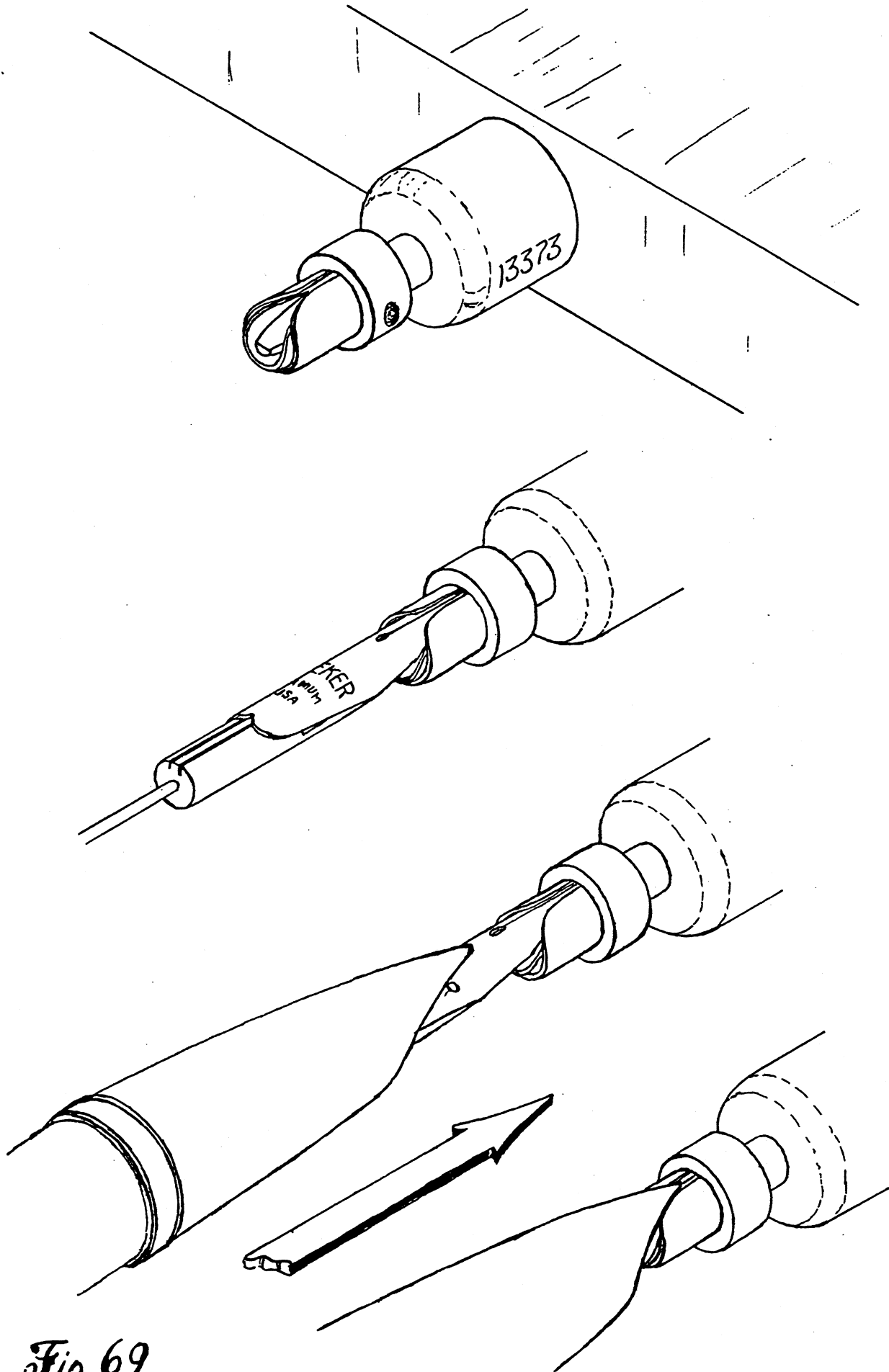
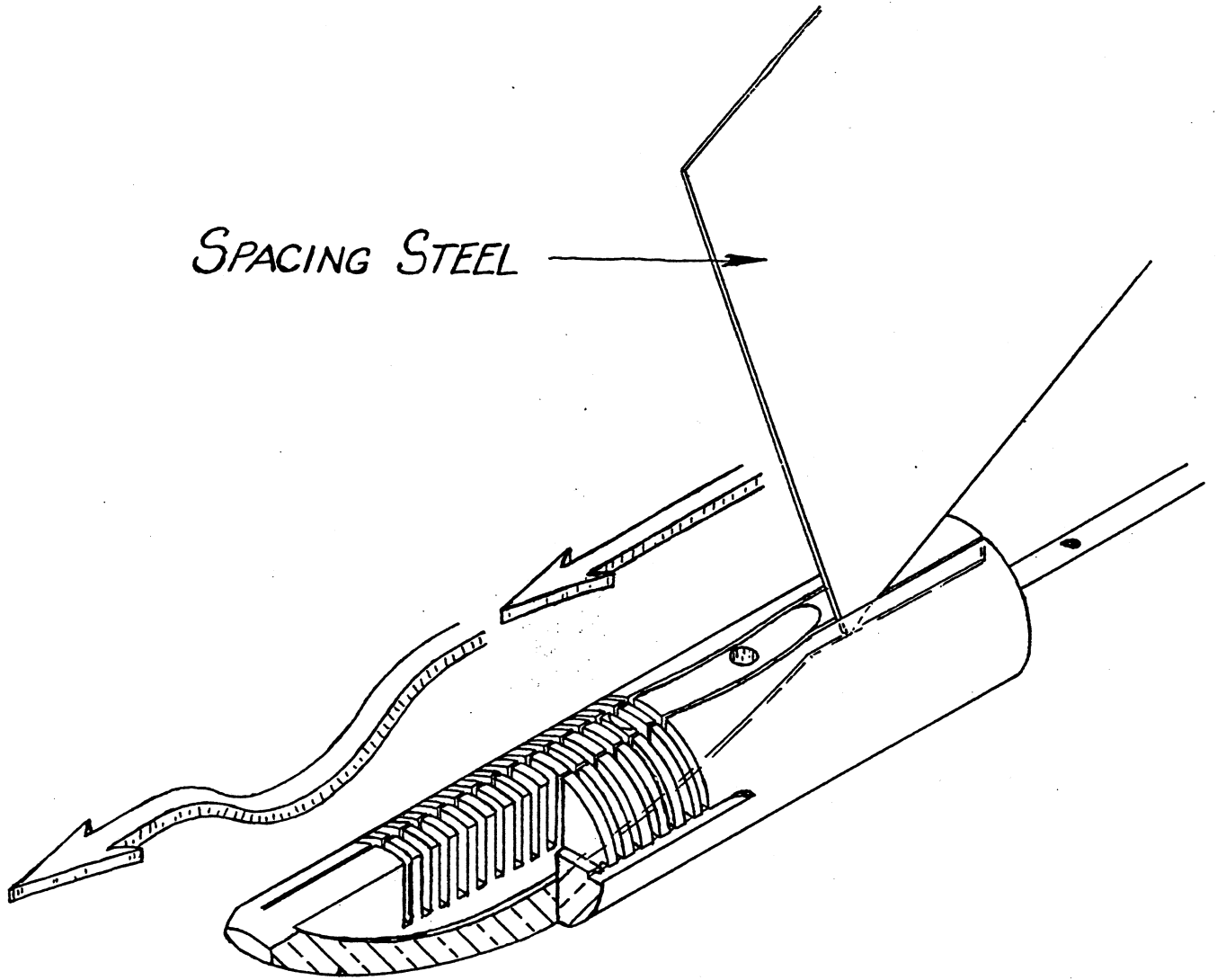

Fig. 69



(LIMPIANDO LOS CANALES)

CLEANING THE FLOW CHANNELS
OF A "21" FEED —

Fig. 70

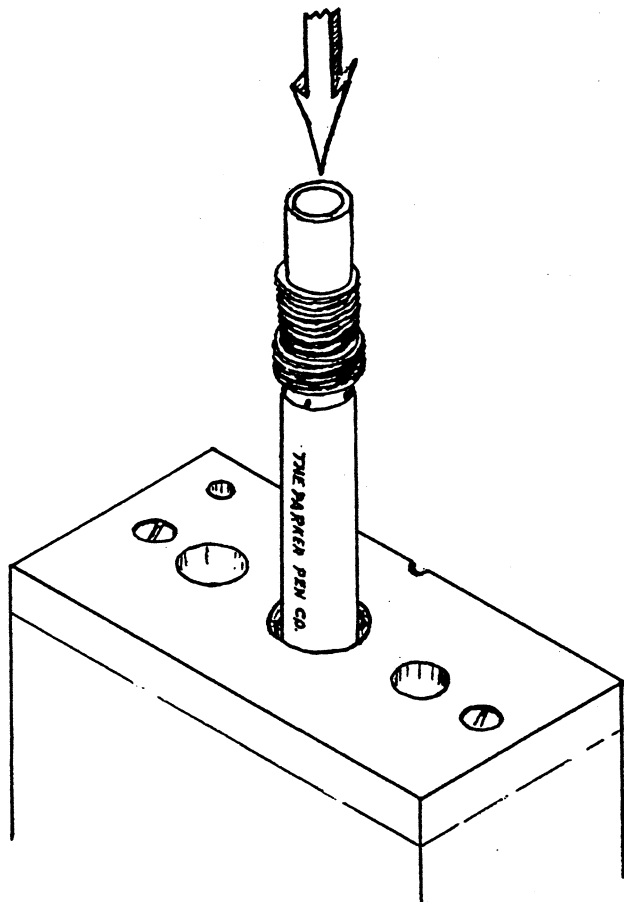
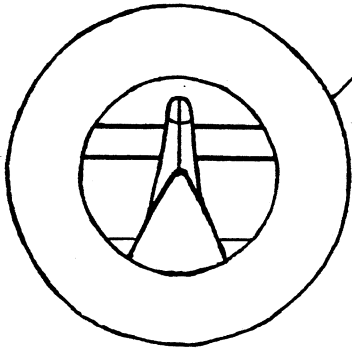
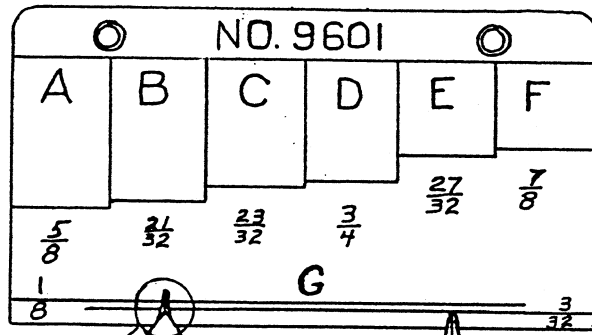
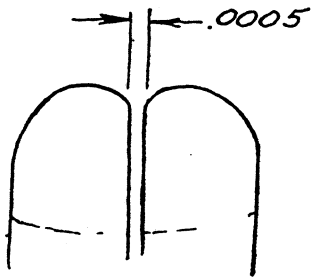

Fig. 71

* 9592 R1



FEED TO NIB PROJECTION
 OSMIRIDIUM PELLET SHOULD
 PROJECT BEYOND $\frac{1}{8}$ " LINE.
 ACTUAL: $-.156" \pm .010$

(LA EXTENSIÓN DE LA PLUMILLA
 (PUNTO DE OSMIRIDIO) AL
 ALIMENTADOR DEBE EXCEDER
 LA DISTANCIA DE $\frac{1}{8}$ ")

NIB TO SHELL PROJECTION
 NIB SHOULD PROJECT TO
 $\frac{3}{32}$ " LINE.

ACTUAL: $-.089" \pm .015"$
 (LA EXTENSIÓN DE LA PLUMILLA
 A LA CÁPSULA DEBE SER $\frac{3}{32}$ ")

(PAPEL 16 Lb)
PAPER
 16 POUNDS

MIN. .003"



13155

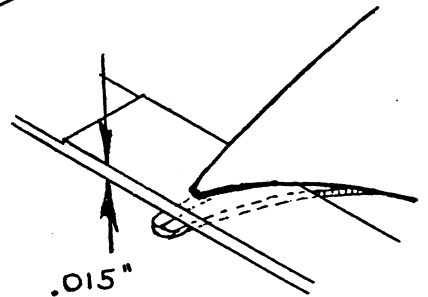

EXCESSIVE
 SPACE
 (ESPACIO EXCESIVO)

MAX. .015"

Fig. 72

(DESMONTANDO LA
TAPA INTERIOR DE
LA TAPA DEL
LAPICERO '21')

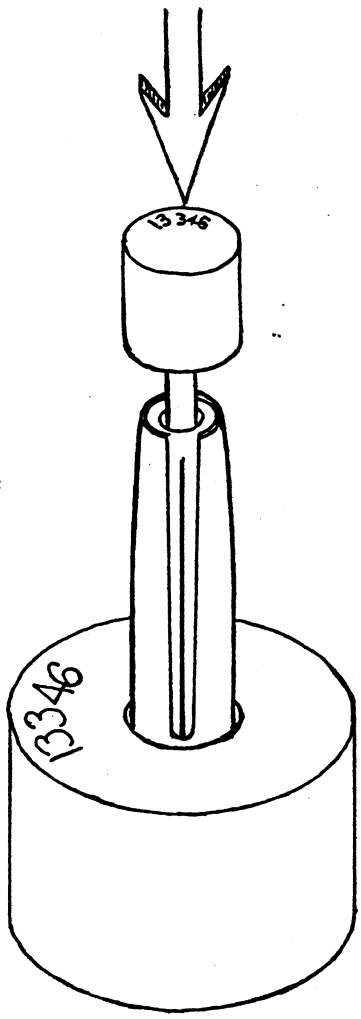

REMOVING
'21'
PENCIL
INNER
CAP
ASSEMBLY

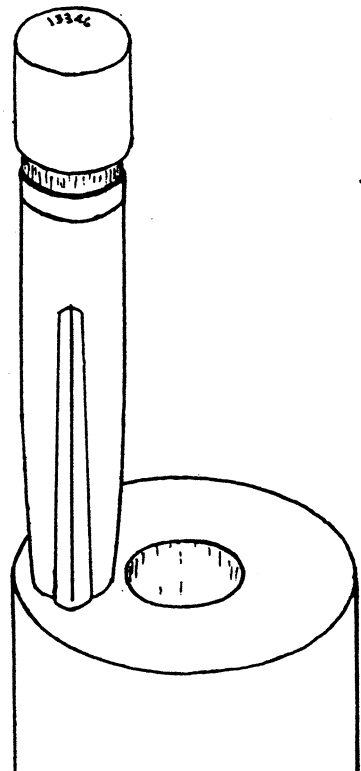

Fig. 73

in Figure 69, insert the nib and feed in the nipple in the proper position as follows:

1. Place the feed in the center portion of the fixture.
2. Insert the nib in the contoured channel above the feed. In this position the nib and feed are established in proper relation to each other and guided so that they will not be damaged in assembly. Used properly, this fixture also maintains proper shell to nib spacing.
3. While holding the nib and feed in the fixture with one finger, slide the shell over the breather tube and feed and onto the nib. Position the shell tip in relation to the nib slit.
4. Press the shell and nipple over the nib and feed until the nib encounters the stop in the nipple. While performing this operation, exert a slight downward pressure on the shell to assure close shell to nib spacing. If all parts have been properly assembled, the nib should project from the shell the proper distance as shown in Figure 72.

Adjustment of the "21" Octanium nib can be accomplished by following the same techniques used on Vacumatic and Duofold nibs. It is best to complete all major adjustments before assembly. To increase the slit in the "21" nib, it is necessary to work from a point as close to the pierce as possible. This slit should be .0005 inch wide for all grades of nibs.

To reassemble the cap, merely reinsert the clip and position it in its specified cut-out. Place the inner cap on Inner Cap Arbor No. 8057 and insert it in the cap. Thread the clip screw into the inner cap and tighten, using the rubber pad.

"21" PENCIL

To disassemble the "21" pencil, unscrew the point using a rubber palm grip. The mechanism differs slightly from the rotary type (Vac-fil) "51" mechanism in that it is not pressed into the plastic barrel and therefore is not interchangeable. Instead it has a hexagonal section which fits into the hexagonal interior of the barrel.

To remove a "21" pencil clip from the cap, use tool No. 13346, Figure 73. Remove the clip screw and thread in the small knurled bolt supplied with the tool. Place the open end of the cap in the tool base. Drive the cap liner and assembly bushing out of the cap by tapping the knurled bolt with a mallet. The clip can then be tipped up and twisted out.

To reassemble the cap, first separate the cap liner and assembly bushing. This can be accomplished by gripping the assembly bushing in the nipple wrench and gently rocking off the cap liner. Insert the clip into the cap and drop in the cap liner. Placing the cap with the clip end down on a hard flat surface, install the assembly bushing in place in the cap opening and carefully drive it in. The small knurled bolt set over the opening acts as a shock absorber and prevents damage to the assembly. Figure 73. Tightly replace the clip screw.

In reassembling the pencil, be certain that the hexagon portion of the mechanism is properly matched with the mating part of the barrel. The movement will not project through the barrel far enough to permit threading the point unless the hexagonal parts are properly mated.

The mechanism uses long Writefine lead.

CLEANSING SOLUTIONS

Sodium Hypochlorite (NaOCl) 5.25% (Max.)

(This solution is commonly sold for laundry bleaching purposes)

Ammonium Hydroxide (NH_4OH) 5.00% (Max.)

(This solution is also commonly sold for laundry purposes)

Caution: All parts cleaned with these solutions must be followed by a fresh water rinse. Vacumatic and Vac-fil filler mechanisms should not be exposed to these solutions.

REFERENCE FITTING CHART FOR REPAIR ASSEMBLY

<u>Name</u>	<u>Retail Price</u>	<u>Nib Size & Model No.</u>	<u>Section</u>	<u>Feed</u>	<u>Feed & Breather Tube Length</u>	<u>Fitting Length</u>
Sub Deb Vacumatic Extended Type	US\$ 5.00	2 - 5.00 #119	2Vac-NS	2 Vac.	1 15/16"	21/32"
Junior Vac Laminated Extended Type	5.00	4 - 5.00 #137	4Vac-NS	4 Vac.	2 21/64"	3/4"
Lady Slender Vacumatic Extended Type	7.50	2 - 5.00 #119	2Vac-NS	2 Vac.	1 15/16"	21/32"
Junior Standard Vacumatic Extended Type	7.50	4 - 5.00 #137	4Vac-NS	4 Vac.	2 21/64"	3/4"
Debutante Vacumatic Extended Type	8.75	2 - 8.75 #119	2Vac-NS	2 Vac.	1 15/16"	21/32"
Major Vacumatic Extended Type	8.75	4 - 8.75 #208	4 - 8.75	4 - 8.75	2 21/64"	3/4"
Sr. Maxima Vacumatic Extended Type	10.00	6 - 10.00 #250	6Vac-NS	6 Vac.	2 19/32"	7/8"
Debutante Imperial Vac Extended Type	12.75	2 - 8.75 #119	2 Imperial	2 Vac.	2 1/8"	21/32"

REFERENCE FITTING CHART FOR REPAIR ASSEMBLY

<u>Name</u>	<u>Retail Price</u>	<u>Nib Size & Model No.</u>	<u>Section</u>	<u>Feed</u>	<u>Feed & Breather Tube Length</u>	<u>Fitting Length</u>
Major Imperial Vacuumatic Extended Type	US\$ 13.75	4 - 8.75 #208	4 Imperial	4 - 8.75	2 5/8"	3/4"
Lady Duo N.S.	5.00	2 Duo #118	2 Duo Slip	Vest Parker	1 7/16"	21/32"
Junior Duo N.S.	5.00	4 Duo #137	4 Duo Slip	4 Parker	1 19/64"	3/4"
Senior Duo N.S.	7.00	6 Duo #250	6 Duo Slip	6 Parker	1 17/32"	7/8"
Lady Sacless Duo Extended Type	5.00	2 Chall. #118	2Vac-MS	2 Vac.	1 15/16"	21/32"
Junior Sacless Duo Extended Type	5.00	4 Chall. #136	4Vac-MS	4 Vac.	2 21/32"	23/32"
Debutante Sacless Duo	8.75	2 - 8.75 #123	2Vac-MS	2 Vac.	1 15/16"	21/32"
Major Sacless Duo	8.75	4 - 8.75 #208	4 Maj. Vac.	4 Vac.	2 31/64"	3/4"

The List Prices indicated are the original selling prices of the various models. These models have been discontinued with the exception of the Junior Vacuumatic and the Sub Deb Vacuumatic which are produced in Canada. These prices are indicated for the sole purpose of identifying the various models.

LIST OF REPAIR TOOLS

Item No.

- ★ 1. Bernard Pliers - for fitting nib and feed in section
- ★ 2. Nib Pliers - for spacing and adjusting nibs
- 3. Flat Brush - for brushing off threads and feeds
- 4. Flat File - for filing and cleaning section nipples
- 5. Round Bristle Brush - for cleaning barrels and caps
- ★ 6. Alcohol Burner - for heating down feeds, shells, etc.
- ★ 7. Pencil Point Drill for Writefine Lead - for drilling out clogged pencil points
- 8. Gold Crayon - for filling in engraving
- 9. Silver Crayon - for filling in engraving
- 10. 1 Sheet Hubert Rouge Paper - for smoothing nibs
- 11. 1 Bottle Liquid Polish 2 oz. - for hand polishing of barrels and caps
- ★ 12. 1 Bottle "51" Cement 2 oz. No. 120 - for cementing shell on barrel threads
- ★ 13. 1 Bottle Vacumatic Cement 2 oz. No. 569 - for cementing screw section threads in barrels
- 14. 1 Bottle of Diaphragm Lubricant 2 oz. No. 188 - to be applied on upper, outer part of diaphragm to aid in inserting filler unit into barrel
- ★ 15. 1 Bottle of Orange Shellac 2 oz. No. 491 - to apply on nipple of sac pen section to hold sac
- ★ 16. 1 Pair of Section Pliers - for removing sections and shells from pen barrels (protect jaws with rubber tubing)
- 17. 1 oz. Bar Rouge Gold Polish - to be applied on cloth for polishing metal parts
- ★ 18. Sac Stretcher - for stretching mouth of sac to be slipped over shellacked section nipple
- 19. 4 Pieces Rubber Tubing - for covering jaws of section pliers and Bernard pliers
- 20. 1 Piece Flat Rubber - to be used as friction hand grip to hold pen barrel, tighten clip screws, etc.
- ★ 21. "51" Nib Puller No. 8573R1 - for removing nib from front end of shell
- ★ 22. Disassembly Block and Rod No. 9592R1 - to drive out feed and nib from section and to tighten or loosen clip screws and to pull button from button filling pens
- ★ 23. Fitting Gauge No. 9601 - for gauging extension of nib to section and extension of nib to feed
- ★ 24. Pressure Bar Insertion Tool No. 10534 - to be inserted into barrel over sac so pressure bar may be fitted without collapsing sac
- ★ 25. Filler Unit Clamp No. 8674 - for removing and inserting all filler units except Senior lock type
- 26. "51" Pen Capacity Gauge - to test capacity of "51" pen
- ★ 27. 10 Flow Channel Cleaners (Spacing Steel) - to clean flow channel of nib
- ★ 28. Magnifying Glass - for inspecting and adjusting nibs
- ★ 29. Arbor No. 8057 for "51" Pen Caps - for removing and fitting clips
- ★ 30. Hook Tool No. 10201 - for extracting old sacs
- ★ 31. Universal Nipple Wrench No. 12827 - for removing shells from Aero-metric Standard and Demi pens and "21" pens
- ★ 32. Barrel Drill No. 13174, 1/32" - to open vent hole on Aero-metric pen barrels
- ★ 33. Flat Plug Gauge No. 13155GF - to gauge ink flow channel of "51" collectors
- ★ 34. Hand Tool for Lead Removal No. 13173
- ★ 35. Aero-metric Feed Insertion Tool No. 12863R1
- 36. Regular Nib Grader No. 11593 - for gauging fineness of nibs
- 37. Extra Fine and Needle Nib Grader No. 11594 - for gauging fineness of nibs
- ★ 38. Clip Screw Wrench No. 11807R1 - for loosening and tightening all clip screw bushings
- 39. "51" Barrel Thread Tap No. 37 - for tapping out filler unit thread in barrel

LIST OF REPAIR TOOLS

Item No.

- 40. Cap Thread Tap "W" - for Junior and Major Vacumatic with extended filler
- 41. Cap Thread Tap "N" - for all Lady pens
- 42. Cap Thread Tap "P" - for Jr. & Standard lock filler Vac, Std. Challenger, Parkette, Jr. Streamline & Jr. Straightshape Duofold
- 43. Cap Thread Tap "Q" - for Sr. lock filler Vac, Sr. Straightshape Duofold and Sr. Streamline Duofold
- 44. Cap Thread Tap "U" - for Sr. Extended Filler Vacumatic
- * 45. Pen Assembly Tool No. 13373 - for installing nib and feed in "21" and Parkette pens
- * 46. Pencil Clip Tool No. 13346 - for removing cap liner on "21" pencils so clip can be removed
- 47. Filler Unit Tester No. 12039
- * 48. 1 2-oz. Bottle of Bostick Cement No. 956 - for Parkette shells
- * 49. "21" Shell Gauge No. 12749GFR2 - for measuring nib, shell and feed extension
- 50. "51" Jammed Cap Remover No. 12029

A bench lathe is needed for the following lathe tools:

- 51. Carbaloy Tipped Turning Tool No. 8675A - for turning blind cap joints on all barrels. (This tool can be resharpened only by a machinist. Do not try to sharpen on oil stone).
- 52. Thread Chasing Tool for 36 Threads - for reducing front barrel thread diameter on Duofold, Vac, Challenger, old style Parkette and Writefine pens
- 53. Oblique Turning Tool - for trimming open end of barrel and cap on all pens
- 54. Narrow Turning Tool - for turning down narrow surfaces on all pens
- 55. Arkansas Oil Stone size 1" x 2" x 4" - for sharpening all turning and facing tools except the Carbaloy
- 56. 3 lb. Bar Pumice - buffing compound used to clean plastic parts
- 57. 2 lb. Bar White Wax Polish - to polish barrels after cleaning

* Denotes basic tools

All prices subject to change without notice. For prices contact your local agent.

1 December 1954

Amendment to Parker Service Manual No. 6996-E

"51" Nib - Collector Positioning

On page 51 of our Service Manual No. 6996-E, we state that in assembling the "51" pen, the air hole in the feed and the pierce and slit in the nib must line up with the wide channel of the collector. This is illustrated in Figure 53 of the manual. Our Research Department has found that the positioning of the feed air hole and the pierce and slit in the nib in regard to the wide channel of the collector is of no importance and does not play any part in the proper functioning of the pen.

While the air hole and slit in the feed and the pierce and slit in the nib should be aligned with each other, it is not necessary that they be aligned with the wide channel of the collector.

Heat-down Operation

Figures 56, 57, and 58 on page 50 of our manual illustrate the heat-down operation to correct irregular ink flow of the "51" pen. This procedure is outlined in the last paragraph of page 51 and the first three paragraphs of page 52.

While this irregular-flow correction method may be used with the old style Vacumatic "51" pens and the first Aero-metric "51" pens, it is not necessary to use it on later "51" pens which are equipped with a slightly different nib. This modified nib has two small dimples on the lower part of its tubular body which are designed to allow automatically the proper nib-shell distance. No heat-down operation is necessary or recommended on pens that are equipped with this new nib, unless there is a definite freedom of movement of the nib under pressure. Incidentally, observing the freedom of movement of the nib while under pressure is a good method to use in testing all models of "51" pens.

Whenever a new dimpled nib is used on an old style pen, it may be necessary to relieve the shell pressure by heating its tip, as outlined in the second paragraph of page 52.

Parker Pen Repair Service ManualTypes of Pens

Present Parker pens operate on three different methods of ink filling.

Sac-Type Reservoir Pens - These include the "51" Aero-metric, 41 and "21" models. It consists of a vacuum-creating mechanism that acts on a flexible material sac to expel air and take in ink. The ink flow in these models is controlled by vacuum in the reservoir, which in turn is controlled by capillary means supplied by the weir channel in the collector. Flow is affected by the flow resistance of the nib slit (the wider the slit, the lower the flow resistance, therefore, a greater flow).

When these pens are placed in a point down position, a certain amount of ink is collected between the nib and feed, and the nib and shell. When the pen is placed in a point up position, the ink in the reservoir falls to the lower end of the reservoir breaking the link between the ink collected at the front end and the ink in the reservoir. The ink in the front end, however, remains there, available for immediate writing unless the pen is stored long enough to permit its evaporation.

Diaphragm-Type Pens - These include the Vacumatic models and the "51" Vac-fill. It consists of a vacuum-creating diaphragm which can be extended by means of a plunger at the end of the barrel. Extension of the diaphragm creates a vacuum within the hollow barrel. When the plunger is released, the ink is sucked into the barrel through a breather tube. Since the breather tube extends some length into the barrel, its opening is always maintained at a higher level than the ink level within the barrel. In this manner each consecutive depression of the plunger expels air -- never ink.

Ink flow is controlled in a similar manner as it is controlled on the sac-type pens.

Capillary Action Pens - The 61 pen is at present the only pen using this ingenious and effortless way to fill itself. It consists of a cell within the reservoir that utilizes a capillary force that draws ink into the pen. Ink is maintained within the reservoir by means of a vacuum force that compensates the force of gravity. These three forces: capillarity, vacuum and gravity - must be maintained at a perfect ratio to provide satisfactory ink filling, ink flowing and ink retaining characteristics.

When the 61 pen is placed in a point up position, the ink in the front end tends to drain back into the reservoir because the ink in the reservoir is connected to the ink in the feed and nib through the long feed which extends from the nib all the way back into the reservoir. The weight of the 4 inch column of ink in the feed is a factor in this drain-back action. In addition, the capillary forces produced within the reservoir tend to pull ink through the feed from the nib. (This is very desirable because it tends to prevent leakage.)

It is necessary, however, to prevent complete drain back of ink from the nib and extremely small pilot channels running at the bottom of the feed channels are provided. In this manner a very high capillary force is created through their narrow width. Thus, a small supply of ink is made available at all times at the tip of the feed, even when the pen has been kept in a point up position for an extended period of time.

Types of Pens

To prevent the ink from draining back from the junction between the nib and the feed, it is important that the nib and the tip of the feed be maintained in close contact.

Since the width of the nib slit and the density of the ink are important factors in the maintenance of capillarity, it is necessary to prevent the ink from draining back by providing the correct nib-slit width. The nib-slit width at and forward of the feed tip must be no more than 0.002 of an inch. (See Illustration I)

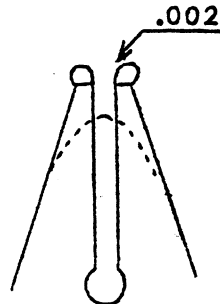

Illustration I

The inner radius of the nib pellet at the slit is an important factor in providing easy starting characteristics. If the nib slit at the pellet has a sharp radius, it will prevent the ink column at the slit from contacting the writing surface, unless a large flow is established. (See Illustration II)

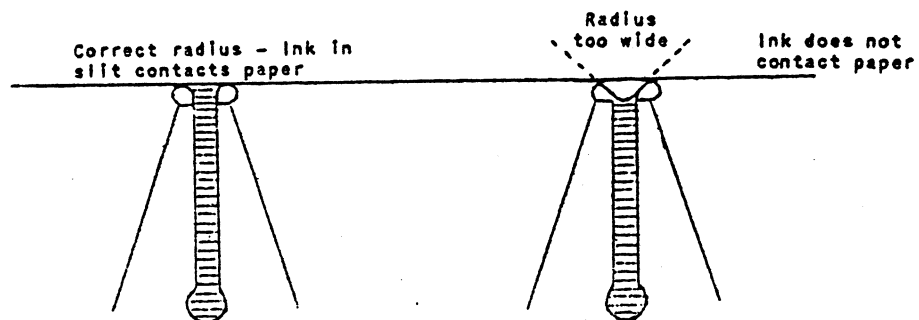

Illustration II

If this condition exists, it will be necessary to wait until the link is established again between the ink at the feed-tip junction and the ink in the reservoir through the larger feed channels.

DHS
rjh
6 August 1958